

Features

Regulated Converter

- 150W industrial grade isolated DC/DC
- Compact, industry standard 1/8th brick format
- 6:1 wide input voltage range (9-60 VDC)
- 3kVDC Isolation
- Efficiency up to 92%
- UL62368-1 certified
- Meets EN50155, EN45545-2 and EN50121-3-2



RPA150E-EW

**150 Watt
Eighth Brick
Single Output**



UL62368-1 certified
 CAN/CSA-C22.2 No. 62368-1 certified
 EN55032 compliant
 EN55011 compliant
 Meets EN50155, EN45545-2 and
 EN50121-3-2

Description

The RPA150E-xxEW is a compact, eighth brick encapsulated DC/DC converter which delivers up to 150W. Its wide input voltage range makes it flexible to install on 12, 24, and 48V rails, and it is especially suitable for 12V, 24V or 48V battery supplies. The tightly-regulated, fully-protected output voltage options are 12V, 24V or 48V - all trimmable over a +/-20% range meaning that the 24V output can also supply 28V for avionic systems, and the 48V can also deliver 57V for PoE applications. Exceptional efficiency of the product translates to very low generated heat, which enables full power operation up to +85°C with only minimal airflow.

Selection Guide

Part Number	Input Voltage Range [VDC]	nom. Output Voltage [VDC]	Output Current max ⁽¹⁾ [A]	Efficiency typ. ⁽²⁾ [%]	Max. Capacitive Load [μF]
RPA150E-4812SEW/P	9-60	12	13	91	5200
RPA150E-4824SEW/P	9-60	24	6	92	2400
RPA150E-4848SEW/P	9-60	48	3	91	1200

Notes:

- Note1: refer to "Output Current"
 Note2: Efficiency is tested at 24Vin, full load and at 25°C

Model Numbering

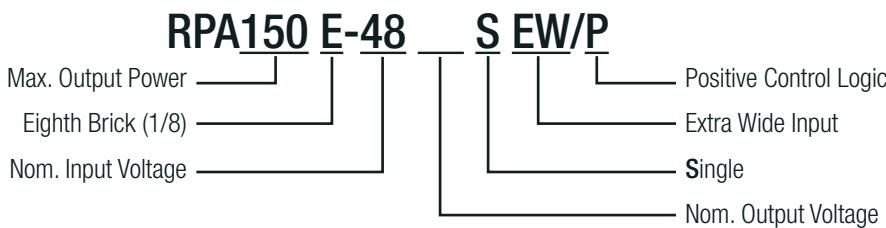

Ordering Examples

RPA150E-4812SEW/P = 9-60Vin, 12V Output, Single, Positive logic control
 RPA150E-4824SEW/P = 9-60Vin, 24V Output, Single, Positive logic control

Specifications (measured @Ta = 25°C, resistive load, nominal Vin and full load unless otherwise noted)

BASIC CHARACTERISTICS					
Parameter	Condition		Min.	Typ.	Max.
Input Voltage Range	nom. Vin = 48VDC (refer to "Line Derating")		9VDC	48VDC	60VDC
Input Surge Voltage	100ms max.				80VDC
Under Voltage Lockout (UVLO)	DC-DC ON DC-DC OFF Hysteresis			8.5VDC 7.5VDC 1VDC	
Input Current	@ 9Vin, full load				17.5A
Quiescent Current	Vin = 24VDC	12Vout 24Vout 48Vout		300mA 160mA 220mA	
Inrush Current				1A ² s	
Output Voltage Trimming ⁽³⁾	leave open if not used, refer to "OUTPUT VOLTAGE TRIMMING"		-20%		+20%
Output Current	refer to "Line Derating"	V _{IN} = 9-24VDC	12Vout 24Vout 48Vout		10A 5A 2.5A
		V _{IN} = 24-60VDC	12Vout 24Vout 48Vout		13A 6A 3A
Minimum Load			0%		
Start-up time	Power ON, CTRL ON/OFF			250ms	
Rise Time	12Vout, 24Vout 48Vout			35ms 25ms	
ON/OFF CTRL	DC-DC ON DC-DC OFF		open or 2.4VDC < V _{CTRL} < 5VDC short or -0.7VDC < V _{CTRL} < 0.8VDC		
Input current of CTRL pin	DC-DC OFF				1.5mA
Standby Current					3mA
Internal Operating Frequency	5Vout, 12Vout 24Vout 48Vout			380kHz 330kHz 290kHz	
Output Ripple and Noise ⁽⁴⁾	20MHz BW at 24Vin		12Vout 24Vout 48Vout	85mVp-p 230mVp-p 200mVp-p	

Notes:

Note3: By trimming up, decrease output current to avoid exceeding rated output power,
By trimming down, do not exceed max. continuous output current

Note4: Measured with: 12Vout= 5x 33µF and 10µF low ESR Polymer and 1µF ceramic capacitor
24 and 48Vout= 33µF and 10µF low ESR Polymer and 1µF ceramic capacitor

Line Derating

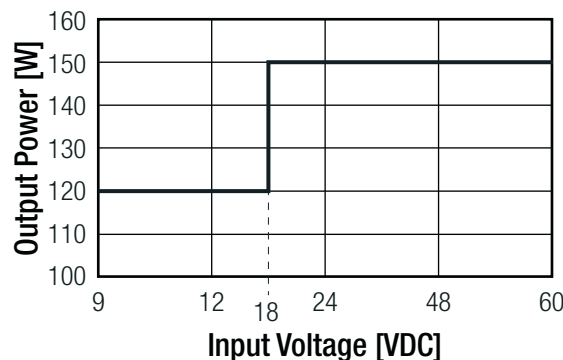

continued on next page

Specifications (measured @Ta = 25°C, resistive load, nominal Vin and full load unless otherwise noted)

RPA150E-4812SEW/P

Efficiency vs. Output Current

V_{IN} = 9-18VDC

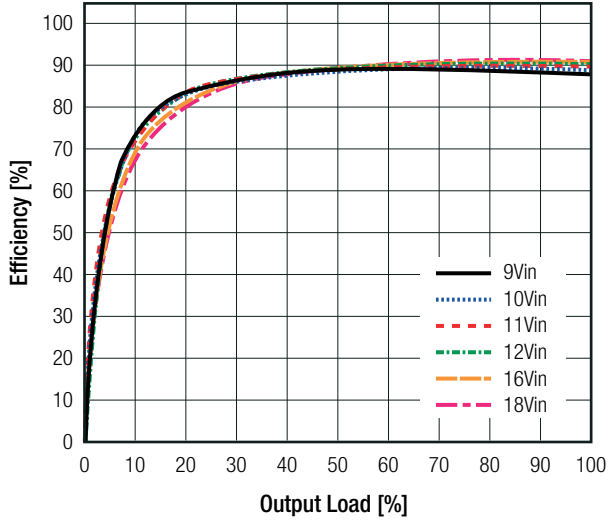

V_{IN} = 18-60VDC

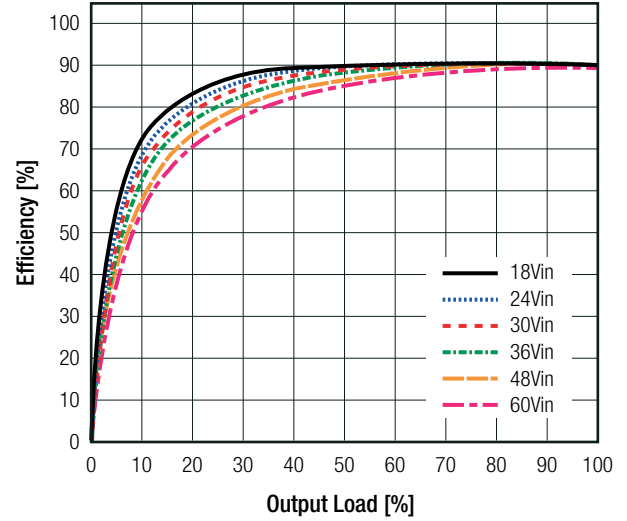

Power Dissipation vs. Output Current

V_{IN} = 9-18VDC

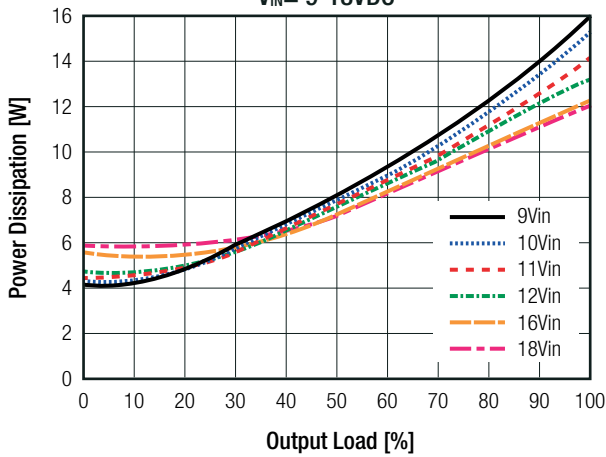

V_{IN} = 18-60VDC

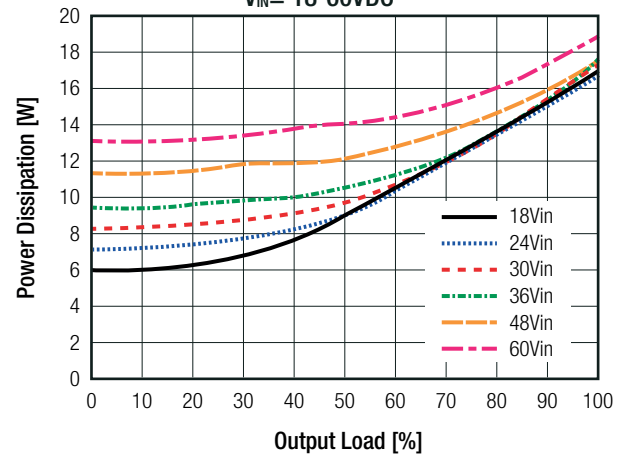

RPA150E-4824SEW/P

Efficiency vs. Output Current

V_{IN} = 9-18VDC

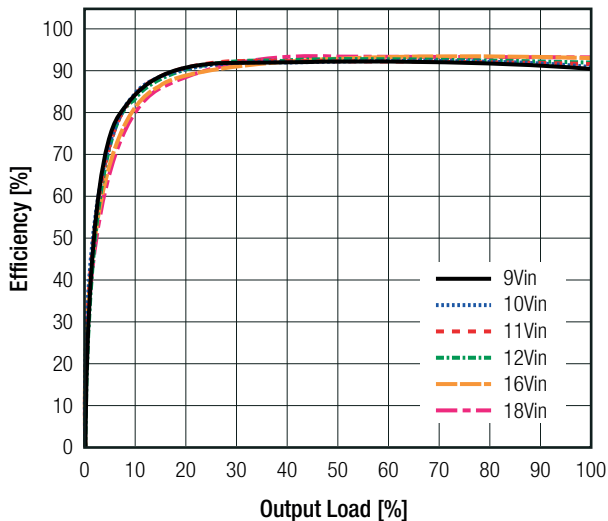

V_{IN} = 18-60VDC

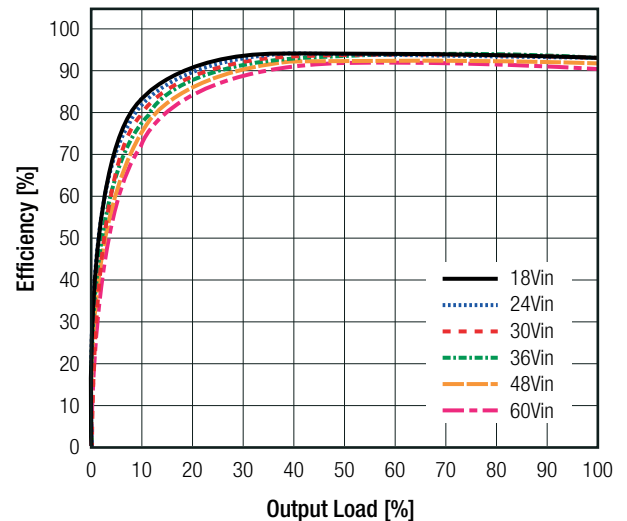

continued on next page

Specifications (measured @Ta = 25°C, resistive load, nominal Vin and full load unless otherwise noted)

RPA150E-4824SEW/P

Power Dissipation vs. Output Current

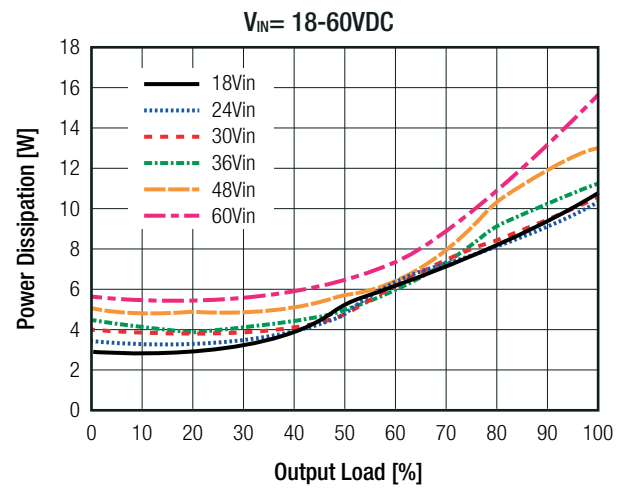
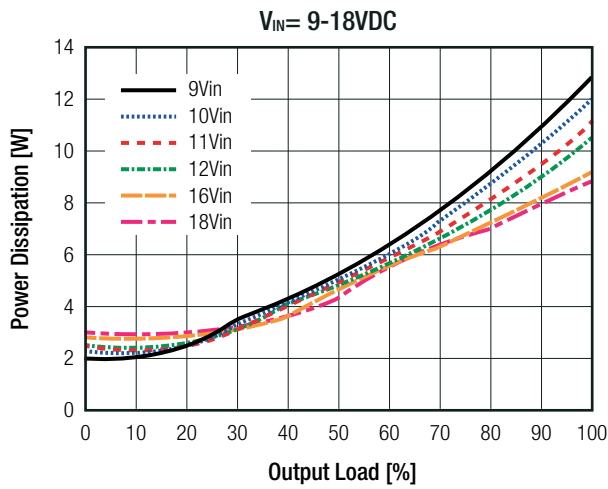

RPA150E-4848SEW/P

Efficiency vs. Output Current

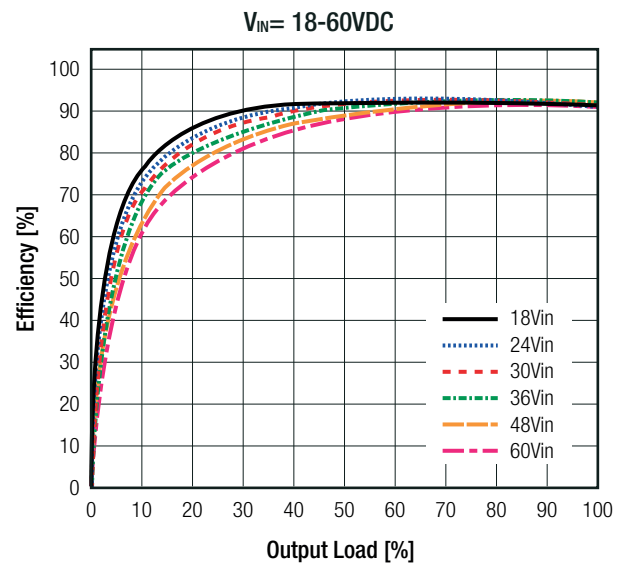
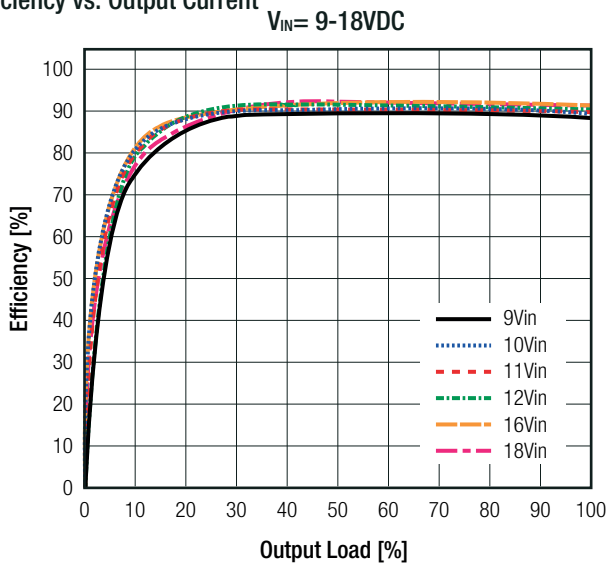

Power Dissipation vs. Output Current

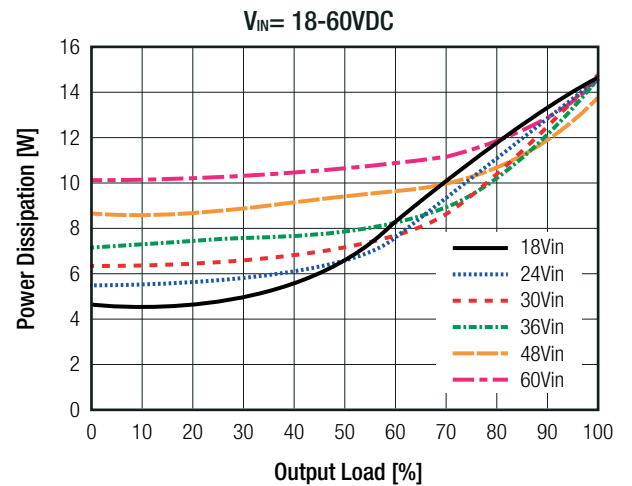
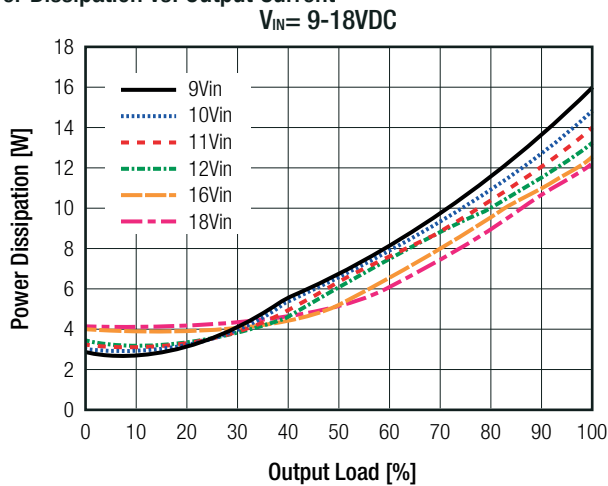

Specifications (measured @Ta = 25°C, resistive load, nominal Vin and full load unless otherwise noted)

ON/OFF CTRL

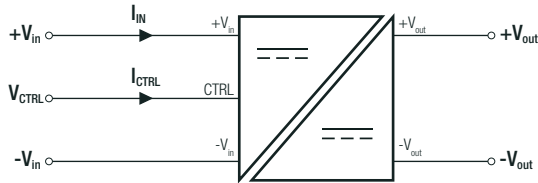

Positive Logic DC-DC ON Open or 2.4VDC <math>V_{CTRL} < 5VDC</math>
 DC-DC OFF Short to -Vin or -0.7VDC <math>V_{CTRL} < 0.8VDC</math>

REMOTE SENSE

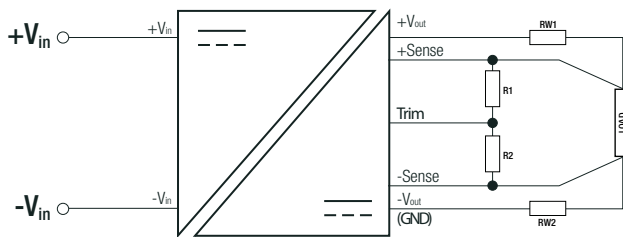

The output voltage can be adjusted by both trim and remote sense. The maximum combined adjustment range $\pm 10\%$. Derate the maximum output if using the trim or sense function.

R_{W1} = wire losses +
 R_{W2} = wire losses -
 R_1 = trim up resistor
 R_2 = trim down resistor

OUTPUT VOLTAGE TRIMMING

RPA150E-EW converters offer the feature of trimming the output voltage over a certain range around the nominal value by using external trim resistors. The values for trim resistors shown in trim tables below are according to standard E96 values; therefore, the specified voltage may slightly vary; they also can be calculated with below shown equation.

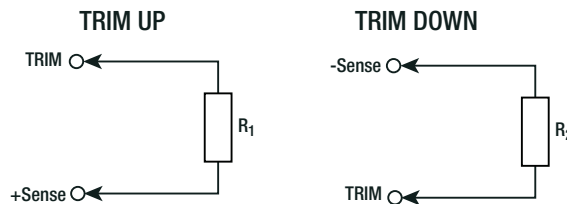

V_{out_nom} = nominal output voltage [VDC]
 V_{out_set} = trimmed output voltage [VDC]
 ΔV_{out} = output voltage change [%]
 V_{ref} = reference voltage [VDC]
 R_{up} = trim up resistor [Ω]
 R_{down} = trim down resistor [Ω]
 $R_1 - R_3$ = internal resistors [Ω]

Calculation:

$$R_{up} = \left[\frac{R_2}{\Delta V_{out}} \right] + R_3$$

$$R_{down} = \left[\frac{V_{ref}}{\Delta V_{out}} \right] - R_1$$

V_{out_nom}	R_1	R_2	R_3	V_{ref}
12VDC	10k22	45k	40k	5.11VDC
24VDC		95k	90k	
48VDC		195k	190k	

Practical Example RPA150E-2412SEW trim up +10%

$$R_{up} = \left[\frac{45k}{0.1} \right] + 40k = 490k\Omega$$

R_{up} according to E96 \approx **487k Ω**

Practical Example RPA150E-2412SEW trim down -10%

$$R_{down} = \left[\frac{5.11}{0.1} \right] - 10k22 = 40k88\Omega$$

R_{down} according to E96 \approx **41k2 Ω**

continued on next page

Specifications (measured @Ta = 25°C, resistive load, nominal Vin and full load unless otherwise noted)

OUTPUT VOLTAGE TRIMMING

RPA150E-4812SEW/P

Trim up	1	2	3	4	5	6	7	8	9	10	[%]
Vout _{set} =	12.12	12.24	12.36	12.48	12.6	12.72	12.84	12.96	13.08	13.2	[VDC]
R _{UP} =	4M53	2M32	1M54	1M18	931k	787k	681k	604k	536k	487k	[Ω]

Trim up	11	12	13	14	15	16	17	18	19	20	[%]
Vout _{set} =	13.32	13.44	13.56	13.68	13.80	13.92	14.04	14.16	14.28	14.4	[VDC]
R _{UP} =	453k	412k	383k	365k	340k	324k	301k	287k	274k	267k	[Ω]

Trim down	-1	-2	-3	-4	-5	-6	-7	-8	-9	-10	[%]
Vout _{set} =	11.88	11.76	11.64	11.52	11.40	11.28	11.16	11.04	10.92	10.8	[VDC]
R _{DOWN} =	499k	243k	162k	118k	90k9	75k	63k4	53k6	46k4	41k2	[Ω]

Trim down	-11	-12	-13	-14	-15	-16	-17	-18	-19	-20	[%]
Vout _{set} =	10.68	10.56	10.44	10.32	10.2	10.08	9.96	9.84	9.72	9.6	[VDC]
R _{DOWN} =	36k5	32k4	29k4	26k1	23k7	21k5	20k	18k2	16k5	15k4	[Ω]

RPA150E-4824SEW/P

Trim up	1	2	3	4	5	6	7	8	9	10	[%]
Vout _{set} =	24.24	24.48	24.72	24.96	25.2	25.44	25.68	25.92	26.16	26.4	[VDC]
R _{UP} =	9M53	4M87	3M24	2M49	2M	1M69	1M43	1M27	1M15	1M05	[Ω]

Trim up	11	12	13	14	15	16	17	18	19	20	[%]
Vout _{set} =	26.64	26.88	27.12	27.36	27.6	27.84	28.08	28.32	28.56	28.8	[VDC]
R _{UP} =	953k	887k	825k	768k	715k	681k	649k	619k	590k	562k	[Ω]

Trim down	-1	-2	-3	-4	-5	-6	-7	-8	-9	-10	[%]
Vout _{set} =	23.76	23.52	23.28	23.04	22.8	22.56	22.32	22.08	21.84	21.6	[VDC]
R _{DOWN} =	499k	243k	162k	118k	90k9	75k	63k4	53k6	46k4	41k2	[Ω]

Trim down	-11	-12	-13	-14	-15	-16	-17	-18	-19	-20	[%]
Vout _{set} =	21.36	21.12	20.88	20.64	20.4	20.16	19.92	19.68	19.44	19.2	[VDC]
R _{DOWN} =	36k5	32k4	29k4	26k1	23k7	21k5	20k	18k2	16k5	15k4	[Ω]

RPA150E-4848SEW/P

Trim up	1	2	3	4	5	6	7	8	9	10	[%]
Vout _{set} =	48.48	48.96	49.44	49.92	50.4	50.88	51.36	51.84	52.32	52.8	[VDC]
R _{UP} =	19M6	10M	6M65	5M11	4M12	3M4	3M01	2M61	2M37	2M15	[Ω]

Trim up	11	12	13	14	15	16	17	18	19	20	[%]
Vout _{set} =	53.28	53.76	54.24	54.72	55.2	55.68	56.16	56.64	57.12	57.6	[VDC]
R _{UP} =	1M96	1M82	1M69	1M58	1M5	1M4	1M33	1M27	1M21	1M18	[Ω]

Trim down	-1	-2	-3	-4	-5	-6	-7	-8	-9	-10	[%]
Vout _{set} =	47.52	47.04	46.56	46.08	45.6	45.12	44.64	44.16	43.68	43.2	[VDC]
R _{DOWN} =	499k	243k	162k	118k	90k9	75k	63k4	53k6	46k4	41k2	[Ω]

Trim down	-11	-12	-13	-14	-15	-16	-17	-18	-19	-20	[%]
Vout _{set} =	42.72	42.24	41.76	41.28	40.8	40.32	39.84	39.36	38.88	38.4	[VDC]
R _{DOWN} =	36k5	32k4	29k4	26k1	23k7	21k5	20k	18k2	16k5	15k4	[Ω]

continued on next page

Specifications (measured @Ta = 25°C, resistive load, nominal Vin and full load unless otherwise noted)

REGULATION

Parameter	Condition	Value
Output Accuracy		±3.0% max.
Line Regulation	low line to high line, full load	±0.2% max.
Load Regulation		0.2% max.
Transient Response ⁽⁵⁾	50%~75% load step, 0.1A/us recovery time	3.0% typ 200µs typ.

Notes:

Note5: measured with a 10uF Low ESR Polymer & 1uF ceramic load cap & electrolytic capacitor

PROTECTIONS

Parameter	Type	Value
Over Voltage Protection (OVP)		120%-150%, hiccup mode
Over Current Protection (OCP)		110%-180%, hiccup mode
Over Temperature Protection (OTP)	test condition: nom. V _{IN} = 24VDC, 80% load, 1m/s airflow	+128°C, auto recovery after cooling down
Isolation Voltage ⁽⁶⁾	tested for 1 minute	I/P to O/P I/P or O/P to baseplate 3kVDC 2.25kVDC
Isolation Resistance	V _{ISO} = 500VDC	10MΩ min.
Isolation Capacitance		500pF typ.
Insulation Grade		basic

Notes:

Note6: For repeat Hi-Pot testing, reduce the time and/or the test voltage

Note7: Refer to local safety regulations if input over-current protection is also required: Recommended fuse: F30A fast-blow type

ENVIRONMENTAL

Parameter	Condition	Value
Operating Temperature Range	with derating (refer to "Derating Graph")	-40°C to +85°C
Maximum Baseplate Temperature		+105°C
Temperature Coefficient		±0.01%/K
Operating Altitude		5500m
Operating Humidity		95% RH
Pollution Degree		PD2
MTBF	80% load, 300LFM, +25°C	≥1400 x 10 ³ hours

continued on next page

Specifications (measured @Ta = 25°C, resistive load, nominal Vin and full load unless otherwise noted)

ENVIRONMENTAL

Derating Graph

(@ Chamber; Test PCB:185 x 185mm 105µm, 4 layer, module vertically mounted)

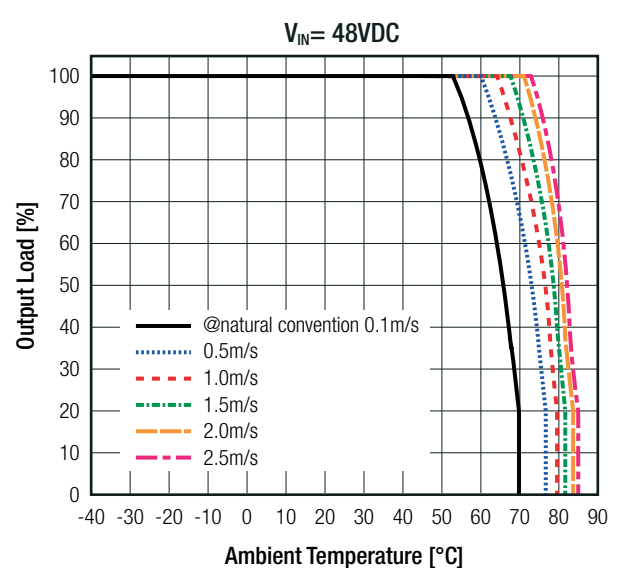
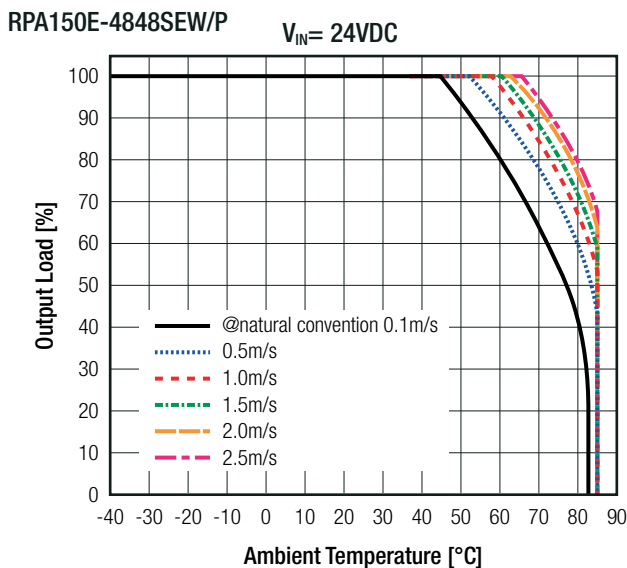
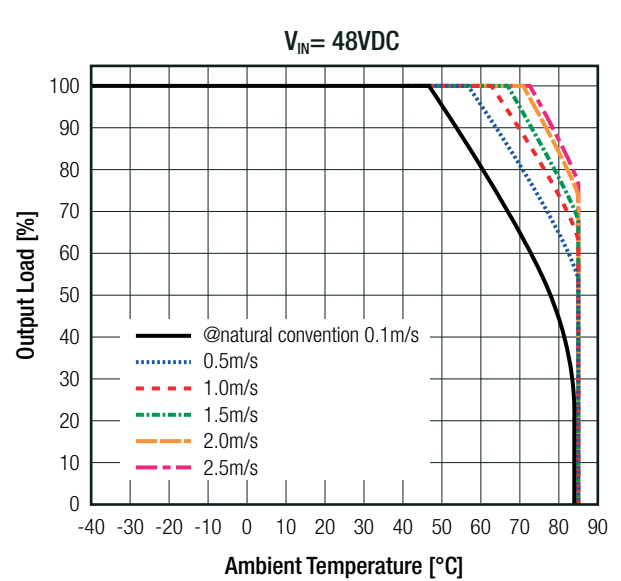
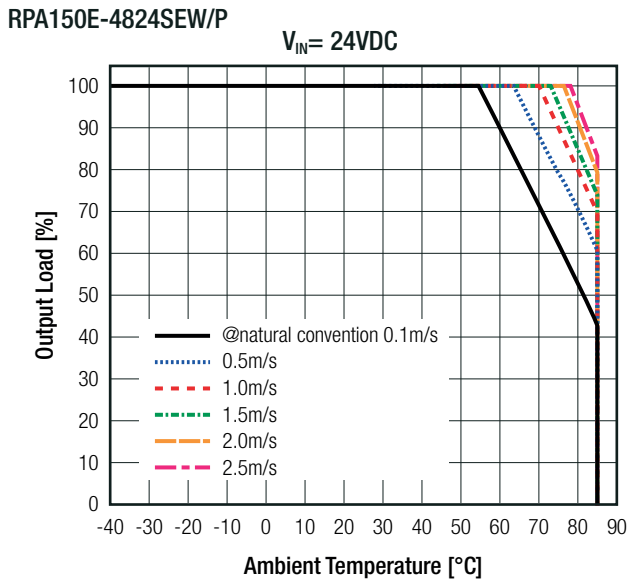
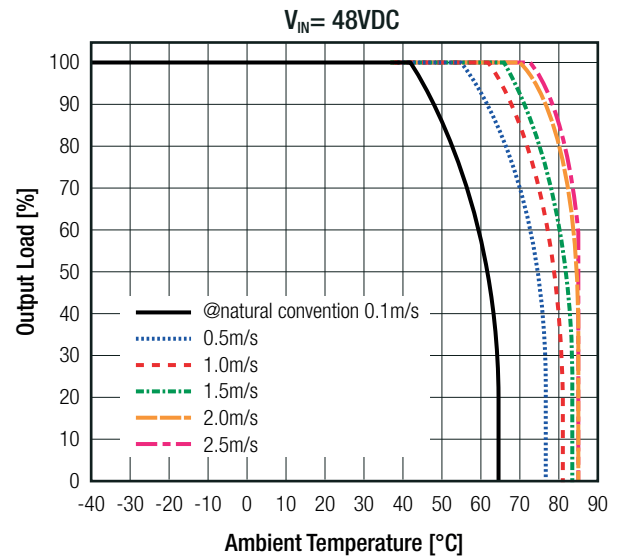
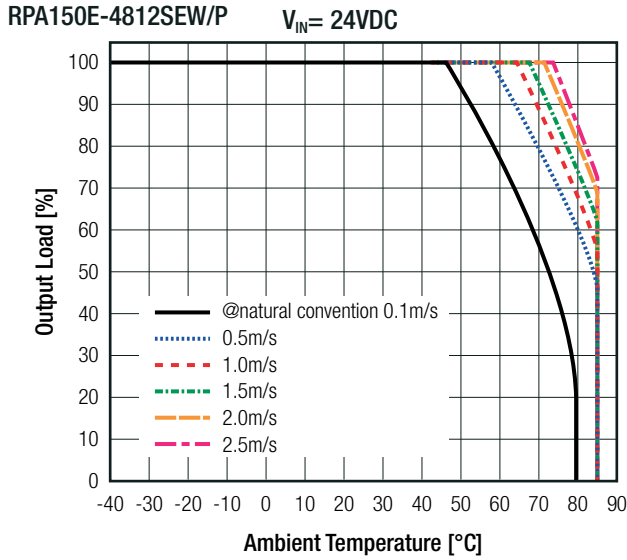

Specifications (measured @Ta = 25°C, resistive load, nominal Vin and full load unless otherwise noted)

SAFETY AND CERTIFICATIONS

Certificate Type (Safety)	Report / File Number	Standard
Audio/Video, information and communication technology equipment - Safety requirements	E224736-A6008-UL E224736-A6009-UL E224736-A6011-UL	UL62368-1:2018 CAN/CSA-C22.2 No. 62368-1:2018
RoHS2		RoHS 2011/65/EU + AM2015/863

EMC Compliance	Condition	Standard
Electromagnetic compatibility of multimedia equipment - Emission requirements	with external components	EN55032:2015, Class A
Industrial, scientific and medical equipment – Radio-frequency disturbance characteristics – Limits and methods of measurement		EN55011
ESD Electrostatic discharge immunity test ⁽⁸⁾	Air ±8kV, Contact ±6kV	IEC61000-4-2:2008, Criteria A EN61000-4-2:2009, Criteria A
Fast Transient and Burst Immunity ⁽⁸⁾	DC Power Port: ±2kV	IEC/EN61000-4-4:2012, Criteria A
Surge Immunity ⁽⁸⁾	DC Power Port: DM ±1kV; CM ±2kV	IEC/EN61000-4-5:2014, Criteria A

Notes:

Note8: An external circuit is required if the module has to meet IEC/EN61000-4-2, IEC/EN61000-4-4, IEC/EN61000-4-5

DIMENSIONS and PHYSICAL CHARACTERISTICS

Parameter	Type	Value
Material	case potting baseplate	plastic, UL94 V-2 silicone, UL94 V-0 aluminum
Package Dimensions (LxWxH)		58.4 x 22.9 x 13.0mm
Package Weight		50.5g typ.

Dimension Drawing (mm)

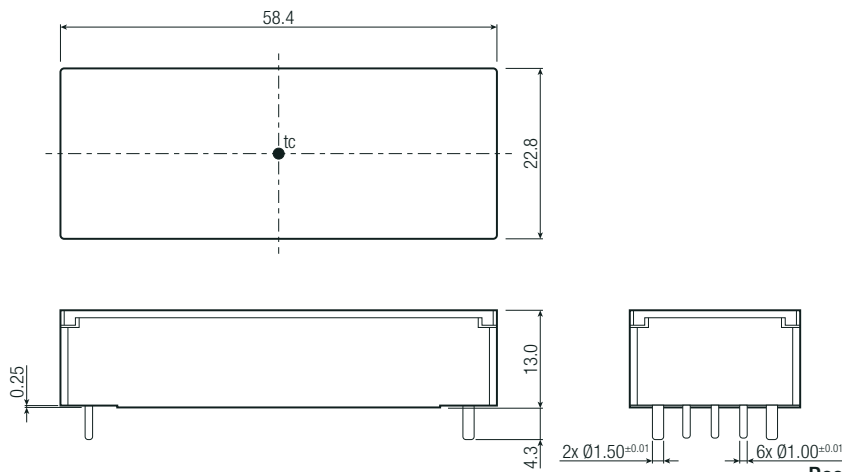
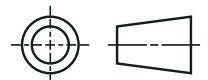

Pinning Information

Pin #	Function
1	-Vin
2	CTRL
3	+Vin
4	+Vout
5	+Sense
6	Trim
7	-Sense
8	-Vout

tc= case temperature measuring point
Tolerance: x.x= ±0.5mm
x.xx= ±0.25mm

Recommended Footprint Details

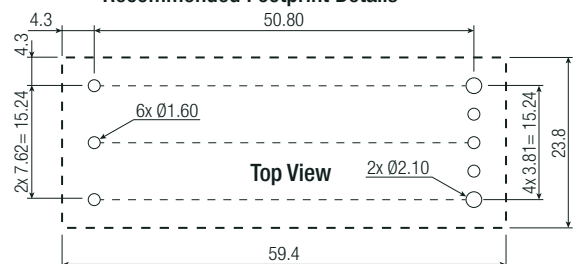

Specifications (measured @Ta = 25°C, resistive load, nominal Vin and full load unless otherwise noted)

PACKAGING INFORMATION		
Parameter	Type	Value
Packaging Dimensions (LxWxH)	cardboard box	221.0 x 128.0 x 33.0mm
Packaging Quantity		6pcs
Storage Temperature Range		-55°C to +125°C
Storage Humidity		95% RH

The product information and specifications may be subject to changes even without prior written notice. The product has been designed for various applications; its suitability lies in the responsibility of each customer. The products are not authorized for use in safety-critical applications without RECOM's explicit written consent. A safety-critical application is an application where a failure may reasonably be expected to endanger or cause loss of life, inflict bodily harm or damage property. The applicant shall indemnify and hold harmless RECOM, its affiliated companies and its representatives against any damage claims in connection with the unauthorized use of RECOM products in such safety-critical applications.