

RACM40-K Series ◊ AC/DC Power Supply

40W ◊ Input: 100V-240VAC

FEATURES

- 1.8“x3.2“x1.2”, encapsulated module
- 40W power from -40°C up to +65°C ambient
- Operating temp. up to +85°C with derating
- OVC III, 4kVAC/1min reinforced isolation
- 2MOPP medical certified
- 5000m (medical/ITE) operating altitude
- Class B EMC filter built-in
- 3 year warranty



Dimensions (LxWxH): 83.23 x 46.43 x 30.40mm (3.2 x 1.8 x 1.2 inch)
185g (0.41 lbs)

APPLICATIONS

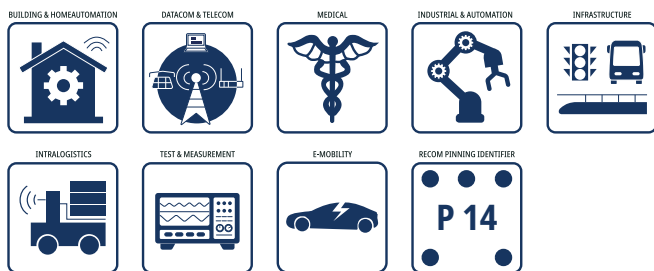

SAFETY & EMC



DESCRIPTION

The compact encapsulated industrial + household + medical grade AC/DC converter series RACM40-K delivers 40 watts of output power from -40°C to +65°C with natural air convection only, and up to +85°C with derating or forced air cooling. With a clear focus on extended thermal performance for systems where space is limited, these 1.8“ x 3.2“ compact modules are designed to gain highest overall efficiency levels over the full output load range from universal AC inputs. The RACM40-K has ANSI/AAMI/IEC 60601-1 medical safety and EN 60601-1-2 medical EMC certifications, 2MOPP, 4kVac/1min isolation and offers OVC III certified to IEC61558. It is additionally certified (CB Report) to IEC/EN 62368-1; IEC61010 and IEC61558-1/-2-16 for industrial applications and IEC/EN 60335-1 for household appliances. The robust built-in class B EMC filter has sufficient margin to allow either Class II or Class I PELV with grounded output installations. The mechanically rugged construction with fully potted encapsulation, 1.6mm pins and additional threaded inserts gives the series enhanced stability against shock and vibrations.

SELECTION GUIDE

Part Number	Operating Input Range ^(3,4) [VAC]	Output Voltage nom. [VDC]	Output Current nom. [mA]	Efficiency typ. ⁽²⁾ [%]	Output Power continuous [W]
RACM40-05SK-T ⁽¹⁾	80-264	5	6000	87	30
RACM40-12SK-T ⁽¹⁾	80-264	12	3334	90	40
RACM40-15SK-T ⁽¹⁾	80-264	15	2667	90	40
RACM40-24SK-T ⁽¹⁾	80-264	24	1667	90	40
RACM40-48SK-T ⁽¹⁾	80-264	48	833	90	40

Note1: “-T” single layer tray packing. Refer to „PACKAGING INFORMATION“

Note2: Efficiency is tested at +25°C with constant resistant mode at full load and 230VAC

RACM40-K Series \diamond AC/DC Power Supply

40W \diamond Input: 100V-240VAC

SELECTION GUIDE (ON REQUEST MOQ \geq 1008PCS)

Part Number	Operating Input Range ^(3, 4) [VAC]	Output Voltage nom. [VDC]	Output Current [mA]	Efficiency typ. ⁽²⁾ [%]	Output Power max. [W]
RACM40-18SK-T ⁽¹⁾	80-264	18	2222	90	40
RACM40-36SK-T ⁽¹⁾	80-264	36	1111	90	40

BASIC CHARACTERISTICS (measured @ T_{AMB}= 25°C, nom. V_{IN}, full load and after warm-up unless otherwise stated)

Parameter	Condition		Min.	Typ.	Max.
Nominal Input Voltage			100VAC		240VAC
Operating Range ^(3, 4)	47-63Hz, 400Hz ⁽⁶⁾		80/85VAC		264VAC
	DC		120VDC		370VDC
Input Current	115VAC				1000mA
	230VAC				500mA
Inrush Current	cold start at 25°C	115VAC			15A
		230VAC			30A
No Load Power Consumption	230VAC			100mW	
Ecodesign Standby Mode Use (Available output power for stated input power)	115VAC	P _{IN} = 0.5W	0.3W		
		P _{IN} = 1W	0.7W		
	230VAC	P _{IN} = 0.5W	0.27W		
		P _{IN} = 1W	0.65W		
Input Frequency Range			47Hz		63Hz
Minimum Load			0%		
Power Factor	115VAC		0.6		
	230VAC		0.5		
Start-up time				160ms	
Rise time				70ms	
Hold-up time	115VAC		16ms		
	230VAC		60ms		
Internal Operating Frequency	100% load at nominal V _{IN}			100kHz	
Output Ripple and Noise ⁽⁶⁾	20MHz BW	5Vout			80mVp-p
		others			1% of nom. V _{OUT}

Note3: Startup from Inputs of 85VAC, specified operation down to 80VAC is ensured by hysteresis.

Note4: The products were submitted for safety files at AC-Input operation (90-264VAC). Start-up from 85VAC.

Note5: Exclusively the 5V output variant holds safety certification for 400Hz input.

Note6: Measurements are made with a 0.1µF MLCC & 10µF E-cap in parallel across output. (low ESR)

Efficiency vs. Load

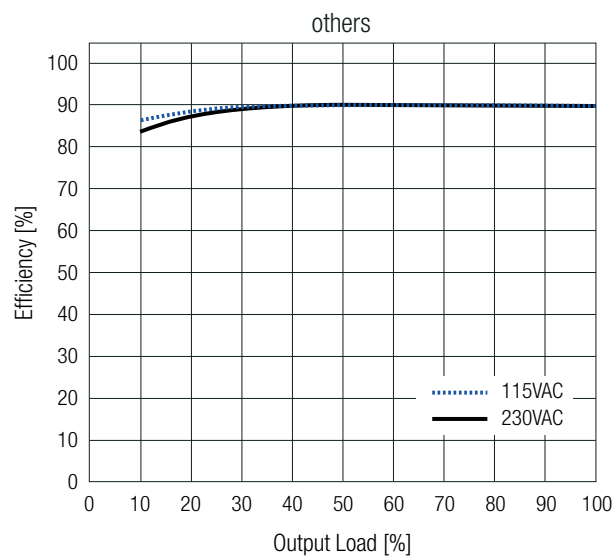
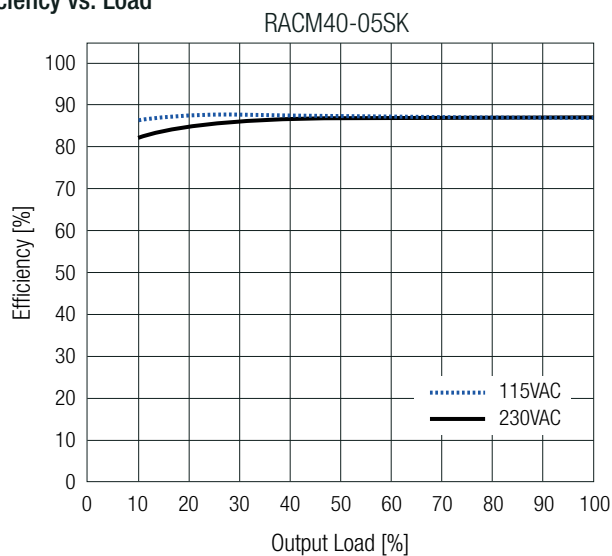

RACM40-K Series \diamond AC/DC Power Supply

40W \diamond Input: 100V-240VAC

REGULATIONS (measured @ $T_{AMB} = 25^{\circ}C$, nom. V_{IN} , full load and after warm-up unless otherwise stated)

Parameter	Condition		Value
Output Accuracy			$\pm 1.0\%$ typ. / $\pm 2.0\%$ max.
Line Regulation	low line to high line	5Vout	$\pm 0.1\%$ typ.
		others	$\pm 0.05\%$ typ.
Load Regulation ⁽⁷⁾	10% to 100% load	5, 12, 15Vout	0.7% typ.
		24, 48Vout	0.5% typ.
Transient Response	25% load step change		3.0% max.
	recovery time		500 μ s max.

Note7: Operation below 10% load will not harm the converter, but specifications may not be met

Deviation vs. Load

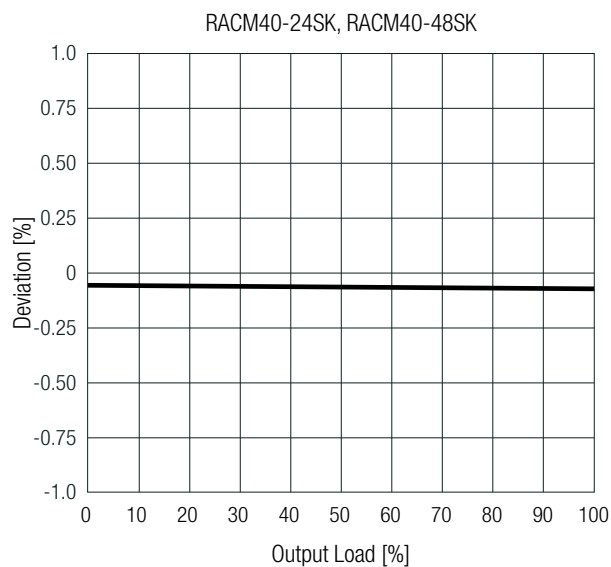
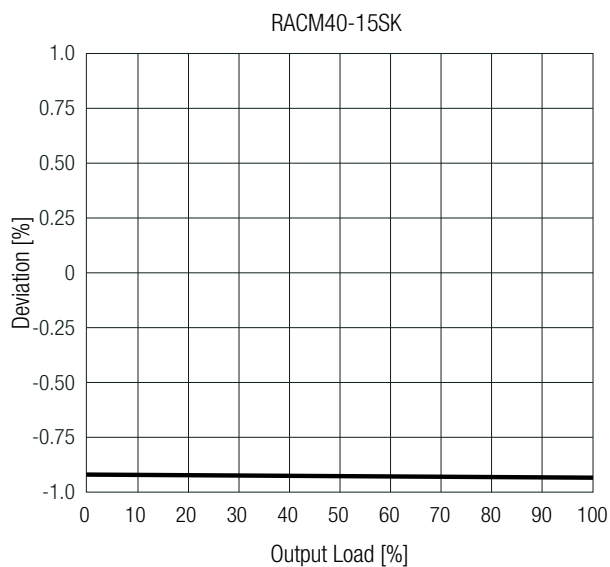
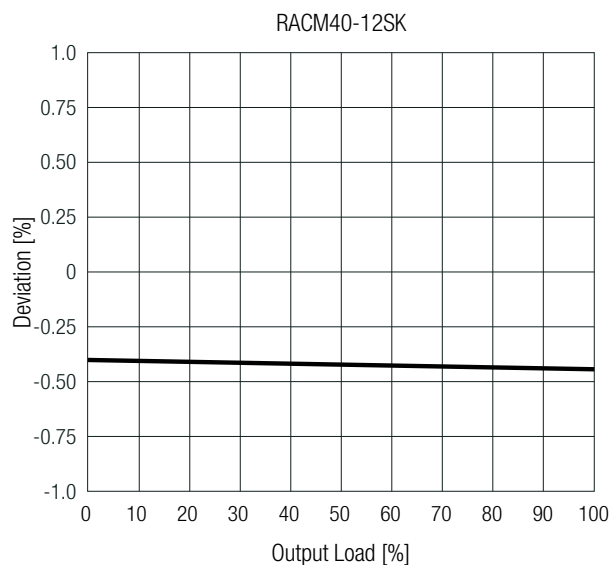
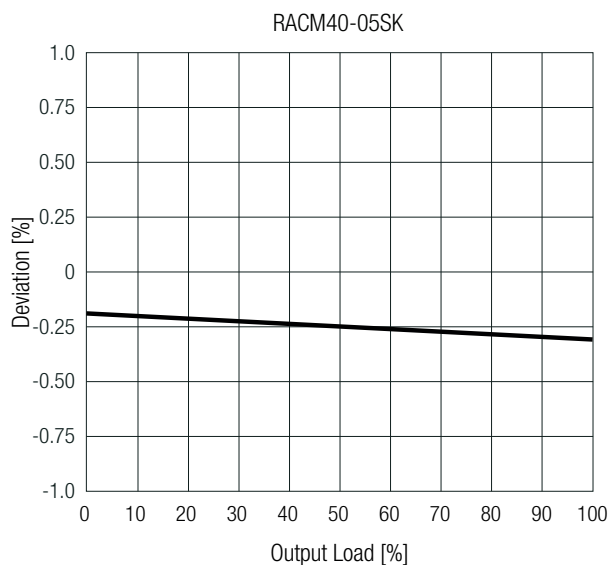

RACM40-K Series \diamond AC/DC Power Supply

40W \diamond Input: 100V-240VAC

PROTECTIONS (measured @ $T_{AMB} = 25^{\circ}\text{C}$, nom. V_{IN} , full load and after warm-up unless otherwise stated)

Parameter	Type			Value
Input Fuse ⁽⁸⁾	internal			T3.15A, slow blow type
Short Circuit Protection (SCP)				hiccup, auto recovery
Over Voltage Protection (OVP)				105% - 120% of nom. V_{out} , hiccup mode
Output reverse Voltage Protection	overrun rate of nominal output			107% - 145% of nom. V_{out} , hiccup mode
Over Current Protection (OCP)				130% - 180% of nom. I_{out} , hiccup mode
Thermal Shutdown	measured on tc point			+130°C typ.
Over Voltage Category (OVC)	according to 61558-1			OVC III (2000m)
	according to 62368-1			OVC II (5000m)
Class of Equipment				Class II
Isolation Voltage ⁽⁹⁾	according to 62368-1	1 minute	I/P to O/P	4kVAC
Isolation Resistance	$V_{ISO} = 500\text{VDC}$			1G Ω min.
Isolation Capacitance	I/P to O/P, 100kHz/0.1V			100pF max.
Insulation Grade	I/P to O/P			reinforced
Means of Protection	I/P to O/P			2MOPP
Medical Device Classification	built-in power supply			designed to support type BF applications
Touch Current	264VAC/63Hz	normal condition		<100 μA
		single fault		<500 μA

Note8: For system integration with DC operation, consider a suitable DC fuse in front of the input

Note9: For repeat Hi-Pot testing, reduce the time and/or the test voltage

ENVIRONMENTAL (measured @ $T_{AMB} = 25^{\circ}\text{C}$, nom. V_{IN} , full load and after warm-up unless otherwise stated)

Parameter	Condition		Value
Operating Ambient Temperature Range	@ natural convection (0.1m/s)	refer to „Derating Graph (10)“	-40°C to +85°C
Maximum Case Temperature			+100°C
Temperature Coefficient			$\pm 0.02\%/K$
Thermal Impedance			6.3K/W
Operating Altitude ⁽¹⁰⁾	according to 62368-1/61010-1 and 60601-1		5000m (OVC II)
	according to 61558-1		2000m (OVC III)
Operating Humidity	non-condensing		20-95% RH max.
Pollution Degree (PD)			PD2
Vibration	10-500Hz, 2G 10min./1cycle, period 60min. along x,y,z axes		according to MIL-STD-202G
	3 axis, 40 g half sine, 11 ms shock		according to IEC 60068-2-27
	5-500Hz, 20m/s ² , 1 Oct/min, 15min		according to IEC 60068-2-65
	10-500Hz; RMS 23.4m/s ² ; 15min		according to IEC 60068-2-64
MTBF	according to MIL-HDBK-217, G.B.	$T_{AMB} = +25^{\circ}\text{C}$	>1006 x 10 ³ hours
		$T_{AMB} = +40^{\circ}\text{C}$	>790 x 10 ³ hours
Design Lifetime	230VAC/60Hz and full load	$T_{AMB} = +40^{\circ}\text{C}$	>98 x 10 ³ hours

Note10: Recognized by safety agency for safe operation up to 5000m. High altitude operation may impact the performance and lifetime.

RACM40-K Series \diamond AC/DC Power Supply

40W \diamond Input: 100V-240VAC

ENVIRONMENTAL (measured @ $T_{AMB} = 25^{\circ}\text{C}$, nom. V_{IN} , full load and after warm-up unless otherwise stated)

Derating Graph ⁽¹¹⁾

(@ Chamber and natural convection 0.1 m/s)

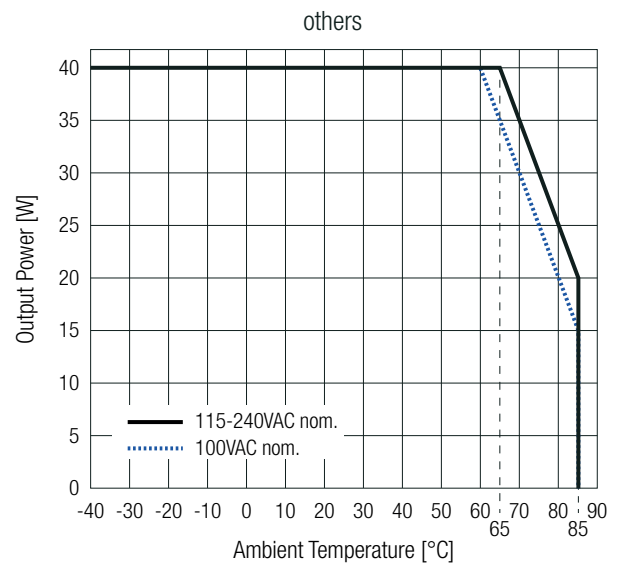
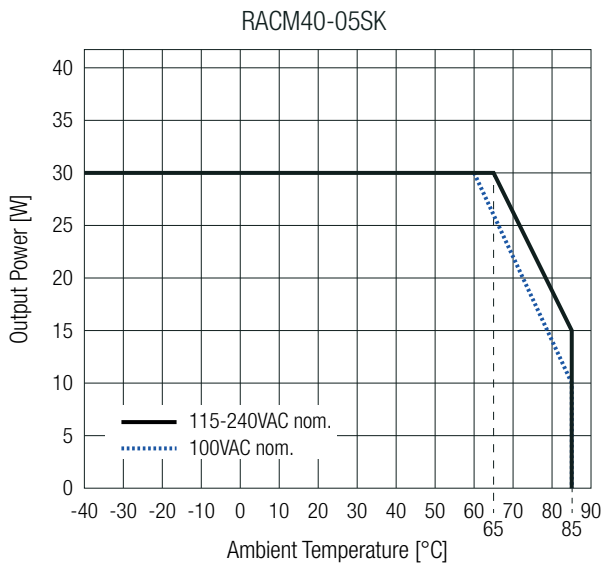

Note11: Output power derating for Line-input of less than 90VAC (derated linearly from 100% at 90VAC to 80% at 80VAC)

SAFETY & CERTIFICATIONS

Certificate Type (Safety)	Report Number	Standard
Medical electrical equipment Part 1: General requirements for basic safety and essential performance	511305-D1001-1/A0/ CO-UL	ANSI/AAMI ES60601-1:2005 + A2:2010/2012 CAN/CSA-C22.2 No. 60601-1:14, 3rd Edition
Medical electrical equipment Part 1: General requirements for basic safety and essential performance		IEC60601-1:2005, 3rd Edition + AM1:2012 EN60601-1:2006 + A1:2013
Audio/Video, information and communication technology equipment - Safety requirements (CB)	60377568 001	IEC62368-1:2014 2nd Edition
Audio/Video, information and communication technology equipment - Safety requirements (LVD)		EN62368-1:2014 + A11:2017
Household and similar electrical appliances – Safety – Part 1: General requirements (LVD)	LCS 200616140AS001	EN60335-1:2012 + A14:2019
Measurement methods for electromagnetic fields of household appliances and similar apparatus with regard to human exposure		EN62233:2008
Electrical Equipment For Measurement, Control, & Laboratory Use; Part 1: General Requirements (CB)	60381411 002	IEC61010-1:2010+A1:2016, 3rd Edition
Electrical Equipment For Measurement, Control, & Laboratory Use; Part 1: General Requirements	60381413 002	EN61010-1:2010+A1:2019
Safety of power transformers, power supplies, reactors & similar products for supply voltages up to 1100V (CB)	60377570 001	IEC61558-1:2005 2nd Edition + A1:2009
Safety of power transformers, power supplies, reactors & similar products for supply voltages up to 1100 V Part 2: Particular requirements (CB)		IEC61558-2-16:2009 1st Edition + A1:2013
Safety of power transformers, power supplies, reactors & similar products for supply voltages up to 1100V	60377571 001	EN61558-1:2005 + A1:2009
Safety of power transformers, power supplies, reactors & similar products for supply voltages up to 1100 V Part 2: Particular requirements		EN61558-2-16:2009 + A1:2013
RoHS2		RoHS 2011/65/EU + AM2015/863

RACM40-K Series \diamond AC/DC Power Supply

40W \diamond Input: 100V-240VAC

SAFETY & CERTIFICATIONS

EMC Compliance according to EN60601-1-2	Condition	Standard
Medical electrical equipment - Part 1-2: General requirements for basic safety and essential performance Collateral standard: Electromagnetic compatibility - Requirements and tests 4th Ed.	4789293779	EN60601-1-2:2015
ESD Electrostatic discharge immunity test	Air $\pm 2, 4, 8, 15kV$; Contact $\pm 8kV$	IEC61000-4-2:2008 , Criteria A EN61000-4-2:2009, Criteria A
Radiated, radio-frequency, electromagnetic field immunity test	9V/m (710, 745, 780, 5240, 5500, 5785MHz) 10V/m (80-2700MHz), 27V/m (385MHz) 28V/m (450, 810, 870, 930, 1720, 1845, 1970, 2450MHz)	IEC/EN61000-4-3:2006 + A2:2010, Criteria A
Fast Transient and Burst Immunity	AC Port L, N, L-N $\pm 2kV$	IEC/EN61000-4-4:2012, Criteria A
Surge Immunity	AC Port L-N: $\pm 0.5, 1, 2kV$ L-PE, N-PE: $\pm 0.5, 1, 2, 4kV$	IEC/EN61000-4-5:2014, Criteria B
Immunity to conducted disturbances, induced by radio-frequency fields	AC Port: 3Vrms (0.15-80MHz) 6Vrms (IMS Band)	IEC61000-4-6:2013, Criteria A EN61000-4-6:2014, Criteria A
Power Magnetic Field Immunity	30A/m	IEC61000-4-8:2009, Criteria A EN61000-4-8:2010, Criteria A
Voltage Dips	30%, 100% (0.5P, 1.0P)	IEC/EN61004-11:2004, Criteria A
Voltage Interruptions		IEC/EN61004-11:2004, Criteria B
EMC Compliance according to EN55032 and EN55035	Condition	Standard
Electromagnetic compatibility of multimedia equipment – Emission Requirements	LCS200616044BE	EN55032:2015
Electromagnetic compatibility of multimedia equipment – Immunity requirements		EN55035:2017
ESD Electrostatic discharge immunity test	Air $\pm 2, 4, 8kV$; Contact $\pm 2, 8kV$	IEC61000-4-2:2008 , Criteria A EN61000-4-2:2009, Criteria A
Radiated, radio-frequency, electromagnetic field immunity test	3V/m (4800-1000MHz, 1800, 2600, 3500, 5000MHz)	IEC/EN61000-4-3:2006 + A2:2010, Criteria A
Fast Transient and Burst Immunity	AC Port: L, N, L-N $\pm 1kV$	IEC/EN61000-4-4:2012, Criteria B
Surge Immunity	AC Port: L-N: $\pm 1kV$	IEC/EN61000-4-5:2014, Criteria B
Immunity to conducted disturbances, induced by radio-frequency fields	AC Port: 3Vrms (0.15-80MHz) 3Vrms (10-30MHz) 1Vrms (30-80MHz)	IEC61000-4-6:2013, Criteria A EN61000-4-6:2014, Criteria A
Power Magnetic Field Immunity	1A/m	IEC61000-4-8:2009, Criteria A EN61000-4-8:2010, Criteria A
Voltage Dips	30% 100%	IEC/EN61004-11:2004, Criteria C IEC/EN61004-11:2004, Criteria B
Voltage Interruptions	100%	IEC/EN61004-11:2004, Criteria C
EMC Compliance according to EN61204-3	Condition	Standard
Low voltage power supplies, d.c. Output Part 3: Electromagnetic compatibility (EMC)	LCS200616049BE	IEC/EN61204-3:2018
ESD Electrostatic discharge immunity test	Air $\pm 2, 4, 8kV$; Contact $\pm 2, 8kV$	IEC61000-4-2:2008 , Criteria A EN61000-4-2:2009, Criteria A
Radiated, radio-frequency, electromagnetic field immunity test	10V/m (80-1000MHz) 3V/m (1400-2000MHz) 1V/m (2000-2700MHz)	IEC/EN61000-4-3:2006 + A2:2010, Criteria A
Fast Transient and Burst Immunity	AC Port: L, N, L-N $\pm 2kV$	IEC/EN61000-4-4:2012, Criteria B
Surge Immunity	AC Port: L-N: $\pm 1kV$	IEC/EN61000-4-5:2014, Criteria B
Immunity to conducted disturbances, induced by radio-frequency fields	AC Port: 10Vrms (0.15-80MHz)	IEC61000-4-6:2013, Criteria A EN61000-4-6:2014, Criteria A
Power Magnetic Field Immunity	30A/m	IEC61000-4-8:2009, Criteria A EN61000-4-8:2010, Criteria A
Voltage Dips	20, 30,60% 100% (0.5P, 1.0P)	IEC/EN61004-11:2004, Criteria C IEC/EN61004-11:2004, Criteria B
Voltage Interruptions	100%	IEC/EN61004-11:2004, Criteria C
Limits of Voltage Fluctuations & Flicker		EN61000-3-3:2013

RACM40-K Series \diamond AC/DC Power Supply

40W \diamond Input: 100V-240VAC

SAFETY & CERTIFICATIONS

EMC Compliance	Report Number	Standard / Criterion
Limitations on the amount of electromagnetic interference allowed from digital and electronic devices	LCS200616043BE	FCC 47 CFR Part 15 Subpart B, Class B
Limitations on the amount of electromagnetic interference allowed from digital and electronic devices, industrial, scientific, and medical equipment	LCS200616045BE	FCC 47 CFR Part 18

DIMENSION & PHYSICAL CHARACTERISTICS

Parameter	Type	Value
Materials	case/baseplate	plastic, (UL94 V-0)
	potting	PU, (UL94 V-0)
	PCB	FR4, (UL94 V-0)
Dimension (LxWxH)		83.23 x 46.43 x 30.40mm 3.2 x 1.8 x 1.2 inch
Weight		185g typ. 0.41 lbs

Dimension Drawing (mm)

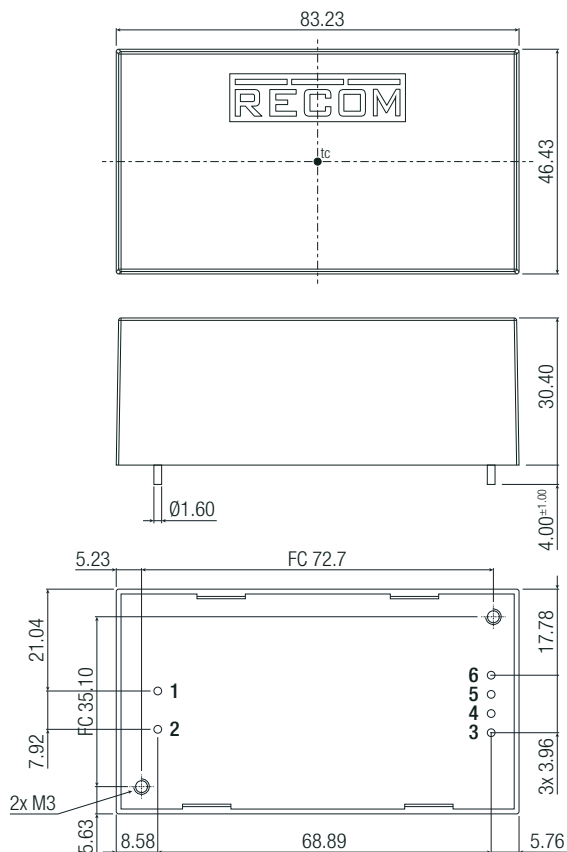
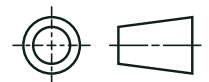

Pinning Information

Pin #	Function
1	VAC in (N)
2	VAC in (L)
3	-Vout
4	-Vout
5	+Vout
6	+Vout

FC= fixing centers
tc= temperature measurement point

Recommend Footprint Details

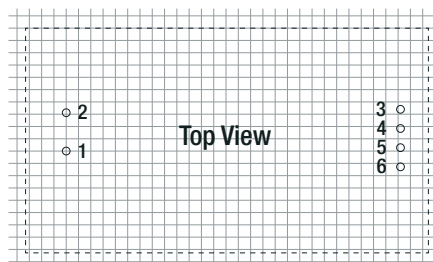

Tolerances:
x.x= ±0.5mm
x.xx= ±0.25mm

RACM40-K Series \diamond AC/DC Power Supply

40W \diamond Input: 100V-240VAC

BLOCK DIAGRAM

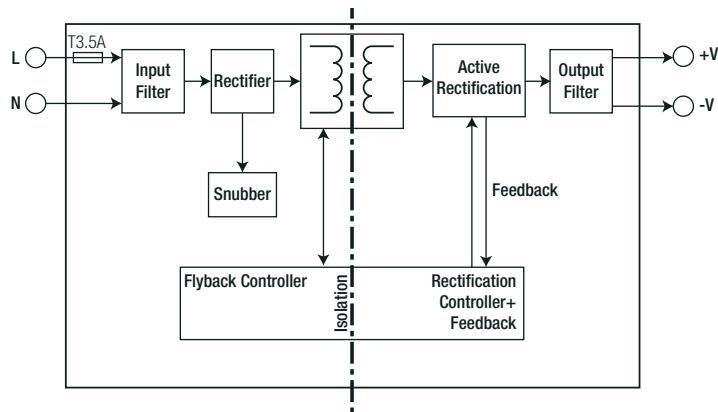

PACKAGING INFORMATION

Parameter	Type	Value
Packaging Dimension (LxWxH)	"-T" = tray	365.0 x 210.0 x 56.0mm
Packaging Quantity		12pcs
Storage Temperature Range		-40°C to +90°C
Storage Humidity	non-condensing	95% max.

The product information and specifications may be subject to changes even without prior written notice. The product has been designed for various applications; its suitability lies in the responsibility of each customer. The products are not authorized for use in safety-critical applications without RECOM's explicit written consent. A safety-critical application is an application where a failure may reasonably be expected to endanger or cause loss of life, inflict bodily harm or damage property. The applicant shall indemnify and hold harmless RECOM, its affiliated companies and its representatives against any damage claims in connection with the unauthorized use of RECOM products in such safety-critical applications.