

Features

Regulated Converter

- 85 to 305Vac input / OVC III
- Full load output power up to 75°C
- 15.4mm low profile
- -40°C to 85°C operating temperature
- <75mW no load power use
- EN55032 class “B” with floating output



RAC03E-K/277

3 Watt
1.45” x 0.95”
Single Output



Description

The cost-efficient RAC03E-K/277 AC/DC converter series has an input range of nominal 100VAC to an enhanced 277V, certified to OVC III overvoltage category; delivering an uncompromising 3 watts of output power with tightly regulated outputs from 3.3V to 24VDC. These low profile, encapsulated print-mountable modules in an industry-standard pinout deliver full output power from -40°C to +75°C and are certified for operation up to +85°C air ambient with output power reduced to 1.8W. This series of AC/DC modules holds international safety certifications for industrial, domestic, ITE, and household use. With 4kVAC input to output isolation, they are suitable for worldwide applications in automation control, industry 4.0, IoT and household automation. Due to their LPS (Limited Power Source) and reinforced class II installation rating for floating outputs and their significantly wide margin to class B EMC compliance without external components, these are the easiest to use, versatile power modules in the industry.

Selection Guide

| Part Number | Input Voltage Range [VAC] | Output Voltage [VDC] | Output Current [mA] | Efficiency typ. (1) [%] |
|------------------|---------------------------|----------------------|---------------------|-------------------------|
| RAC03E-3.3SK/277 | 85-305 | 3.3 | 900 | 68 |
| RAC03E-05SK/277 | 85-305 | 5 | 600 | 73 |
| RAC03E-12SK/277 | 85-305 | 12 | 250 | 75 |
| RAC03E-15SK/277 | 85-305 | 15 | 200 | 77 |
| RAC03E-24SK/277 | 85-305 | 24 | 125 | 79 |

Notes:

Note1: Efficiency is tested at nominal input and full load at +25°C ambient

Model Numbering



Specifications (measured @ Ta= 25°C, nom. Vin, full load and after warm-up unless otherwise stated)

| BASIC CHARACTERISTICS | | | | | |
|---|----------------------------------|----------------------------|-----------------|--------|----------------------|
| Parameter | Condition | | Min. | Typ. | Max. |
| Nominal Input Voltage | 50/60Hz | | 100VAC | | 277VAC |
| Input Voltage Range (2,3) | 47-63Hz DC | | 85VAC 120VDC | 277VAC | 305VAC 430VDC |
| Input Current | 115VAC 230VAC 277VAC | | | | 70mA 50mA 40mA |
| Inrush Current | cold start at 25°C | 115VAC 230VAC 277VAC | | | 10A 20A 25A |
| No load Power Consumption | | | | | 75mW |
| ErP Standby Mode Conformity (Maximum output power available for stated maximum input power) | Module Input Power= 0.5W 1.0W | | | | 0.32W 0.68W |
| Notes: | | | | | |
| Note2: The products were submitted for safety files at AC-Input operation (90-305VAC) | | | | | |
| Note3: Refer to “Derating Graph (7)” | | | | | |
| continued on next page | | | | | |

YOU MAY ALSO LIKE
 Please consider this alternatives:

RAC03-K

- UL/IEC/EN62368-1 certified
- CAN/CSA C22.2 No. 62368-1 certified
- EN60335-1 certified
- EN62233 certified
- IEC/EN61558-1/2-16 certified
- EN55032/EN55035 compliant
- EN55014-1/-2 compliant
- EN61204-3 compliant
- FCC Part 15 compliant
- CB Report

Specifications (measured @ Ta= 25°C, nom. Vin, full load and after warm-up unless otherwise stated)

BASIC CHARACTERISTICS

| Parameter | Condition | | Min. | Typ. | Max. |
|--|--------------------------|----------------------|------|-------|------------------------|
| Input Frequency Range | AC Input | | 47Hz | | 63Hz |
| Minimum Load | | | 0% | | |
| Power Factor | 115VAC | | 0.55 | | |
| | 230VAC | | 0.45 | | |
| | 277VAC | | 0.40 | | |
| Start-up Time | | | | 15ms | |
| Rise Time | | | | 10ms | |
| Hold-up Time | 115VAC | | | 15ms | |
| | 230VAC | | | 80ms | |
| | 277VAC | | | 120ms | |
| Internal Operating Frequency | 100% load at nominal Vin | | | | 132kHz |
| Output Ripple and Noise ⁽⁴⁾ | 20MHz BW | 3.3, 5Vout others | | | 120mVp-p 1% of Vout |

Notes:

Note4: Measurements are made with a 0.1µF MLCC & 10µF E-cap in parallel across output. (low ESR)

Efficiency vs. Load

RAC03E-3.3SK/277

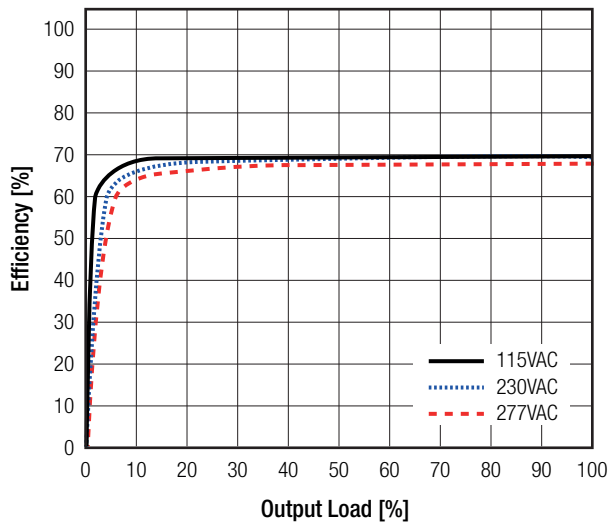

RAC03E-05SK/277

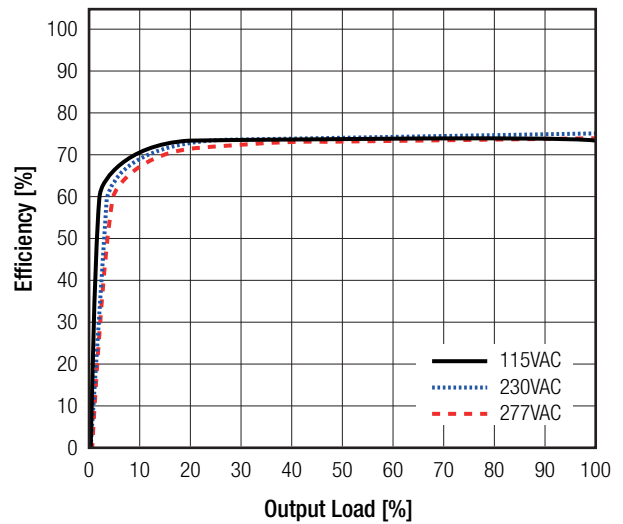

RAC03E-12SK/277 / RAC03E-24SK/277

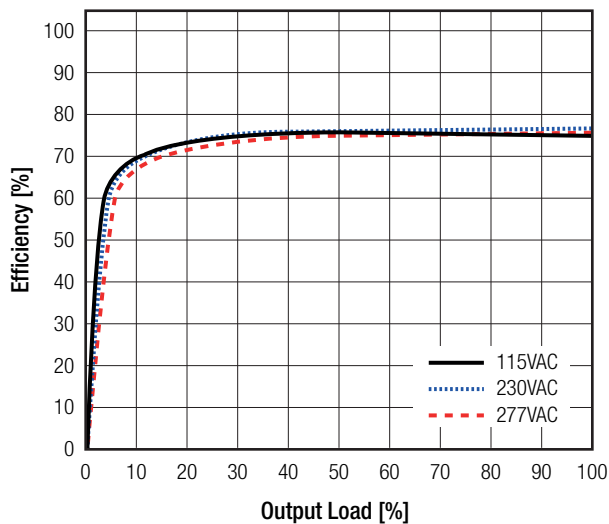

RAC03E-15SK/277

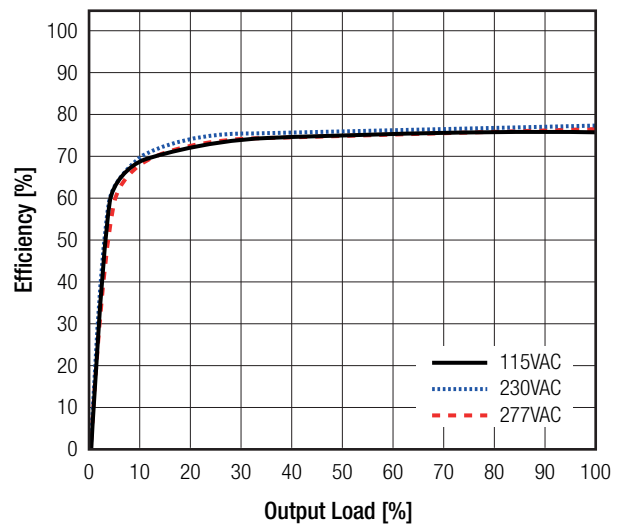

continued on next page

Specifications (measured @ Ta= 25°C, nom. Vin, full load and after warm-up unless otherwise stated)

REGULATIONS

| Parameter | Condition | Value |
|--------------------------------|---------------------------------------|-------------------------|
| Output Accuracy | | ±1.0% max. |
| Line Regulation | low line to high line, full load | ±0.5% typ. |
| Load Regulation ⁽⁵⁾ | 10% to 100% load | 0.5% typ. |
| Transient Response | 10% load step change recovery time | 6.0% max. 350µs typ. |

Notes:

Note5: Operation below 10% load will not harm the converter, but specifications may not be met

Deviation vs. Load

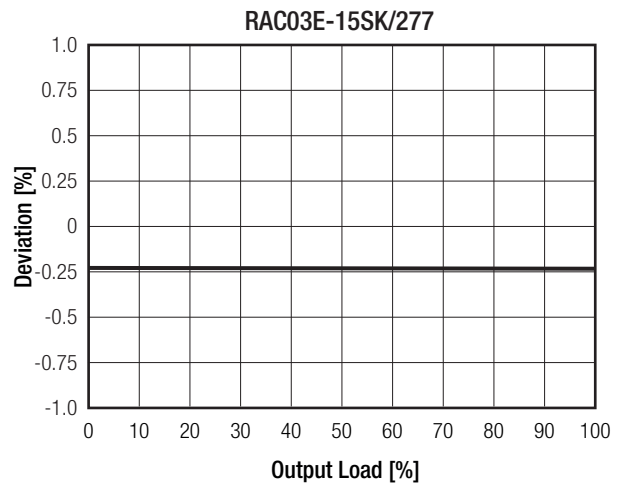
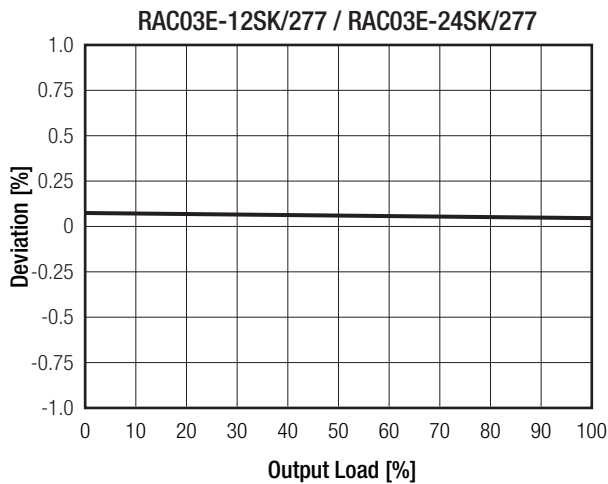
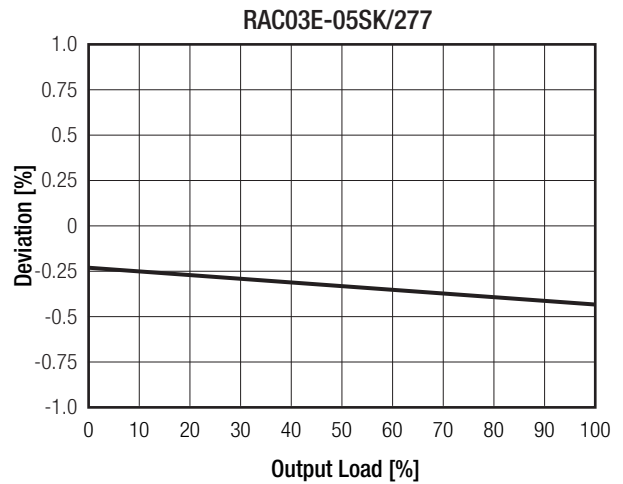
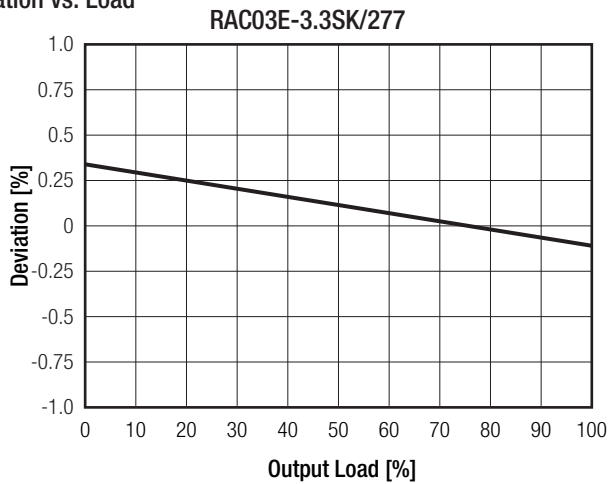

PROTECTIONS

| Parameter | Type/Condition | Value |
|----------------------------------|----------------|----------------------------|
| Input Fuse | internal | fusible resistor |
| Short Circuit Protection (SCP) | | Hiccup mode, auto recovery |
| Over Voltage Protection (OVP) | | 120% - 260%, hiccup mode |
| Over Current Protection (OCP) | | 120% - 300%, hiccup mode |
| Over Voltage Category (OVC) | | OVCII OVCIII |
| Isolation Voltage ⁽⁶⁾ | I/P to O/P | 1 minute 4kVAC |

Notes:

Note6: For repeat Hi-Pot testing, reduce the time and/or the test voltage

continued on next page

Specifications (measured @ Ta= 25°C, nom. Vin, full load and after warm-up unless otherwise stated)

PROTECTIONS

| Parameter | Condition | Value |
|-----------------------|--------------------------------------|-------------|
| Isolation Resistance | I/P to O/P, Isolation Voltage 500VDC | 1GΩ min. |
| Isolation Capacitance | I/P to O/P, 100KHz/0.1V | 100pF max. |
| Leakage Current | @ 277VAC | 0.25mA max. |
| Insulation Grade | | reinforced |

ENVIRONMENTAL

| Parameter | Condition | | Value |
|-----------------------------|----------------------------------|-------------------------------|---|
| Operating Temperature Range | @ natural convection 0.1m/s | refer to "Derating Graph (7)" | -40°C to +85°C |
| Maximum Case Temperature | | | +95°C |
| Temperature Coefficient | | | ±0.03%/K |
| Operating Altitude | | | 2000m |
| Operating Humidity | non-condensing | | 20% - 90% RH max. |
| Pollution Degree | | | PD2 |
| Vibration | | | 10-500Hz, 2G10min./1cycle, period 60min. each along x,y,z axes |
| MTBF | according to MIL-HDBK-217F, G.B. | +25°C +40°C | 2260 x 10 ³ hours 2040 x 10 ³ hours |
| Design Lifetime | 230VAC/60Hz and full load +50°C | | >30 x 10 ³ hours |

Derating Graph (7)

(@ Chamber and natural convection 0.1 m/s)

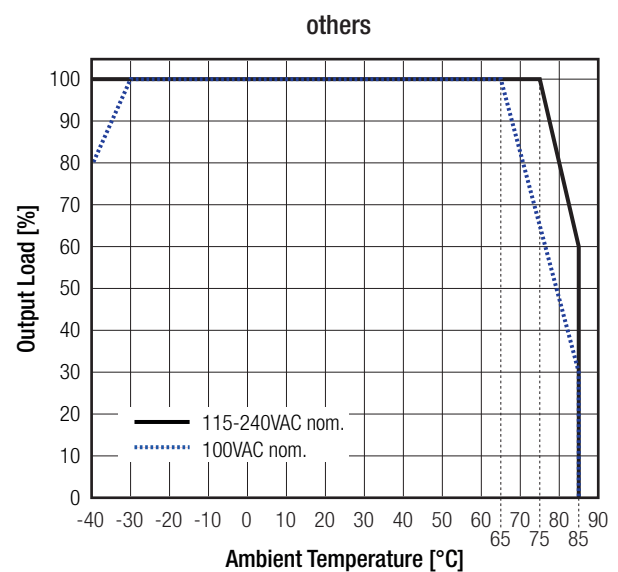
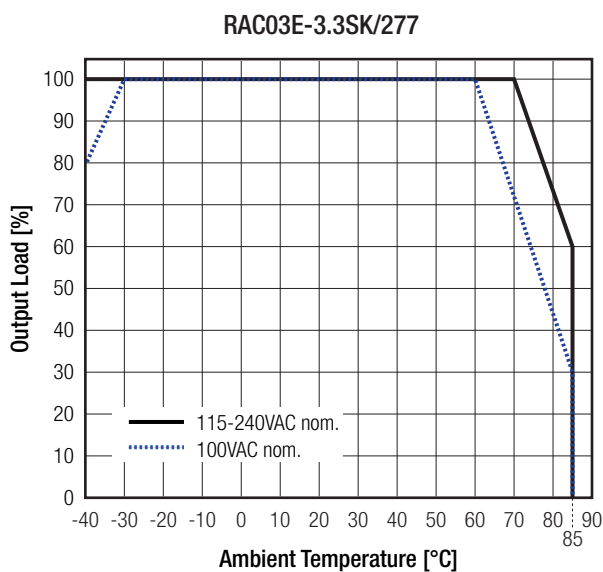

Notes:

Note7: Output power derating for Line-input of less than 90VAC (de-rate linearly from 100% at 90VAC to 85% at 85VAC)

Specifications (measured @ Ta= 25°C, nom. Vin, full load and after warm-up unless otherwise stated)

| SAFETY AND CERTIFICATION | | |
|--|---|---|
| Certificate Type (Safety) | Report Number | Standard |
| Audio/Video, information and communication technology equipment - Part 1: Safety requirements | E491408-A6014-UL | UL62368-1:2019 3rd Edition CAN/CSA-C22.2 No. 62368-1:2019 |
| Audio/Video, information and communication technology equipment - Part1: Safety requirements (CB Scheme) | 200703001-1 | IEC62368-1:2018 3rd Edition |
| Audio/Video, information and communication technology equipment - Part1: Safety requirements (LVD) | | EN IEC 62368-1:2020+A11:2020 |
| Audio/Video, information and communication technology equipment - Part1: Safety requirements (LVD) | 200703001-3 | EN62368-1:2014+A11:2017 |
| Household and similar electrical appliances – Safety – Part 1: General requirements (LVD) | | EN60335-1:2012+A2:2019 |
| Measurement methods for electromagnetic fields of household appliances and similar apparatus with regard to human exposure | 60413198001 | EN62233:2008 |
| Safety of power transformers, power supplies, reactors and similar products for supply voltages up to 1100 V (CB Scheme) | 60394453 001 | IEC61558-1:2005 2nd Edition + A1:2009 |
| Safety of power transformers, power supplies, reactors and similar products for supply voltages up to 1100 V | 60394454 001 | EN61558-1:2005 + A1:2009 |
| Safety of power transformers, power supplies, reactors and similar products for supply voltages up to 1100 V Part 2: Particular requirements (CB Scheme) | 60394453 001 | IEC61558-2-16:2009 1st Edition + A1:2013 |
| Safety of power transformers, power supplies, reactors and similar products for supply voltages up to 1100 V Part 2: Particular requirements | 60394454 001 | EN61558-2-16:2009 + A1:2013 |
| Safety of power transformers, power supplies, reactors and similar products for supply voltages up to 1100 V | CN21HNQK001 | IEC61558-1:2017 |
| | CN21ZHJ6001 | EN IEC 61558-1:2019 |
| Safety of power transformers, power supplies, reactors and similar products for supply voltages up to 1100 V Part 2: Particular requirements | CN21HNQK001 | IEC61558-2-16:2009 1st Edition + A1:2013 |
| | CN21ZHJ6001 | EN61558-2-16:2009 + A1:2013 |
| RoHS2 | | RoHS 2011/65/EU + AM2015/863 |
| EMC Compliance | | |
| | Condition | Standard / Criterion |
| Electromagnetic compatibility of multimedia equipment – Emission Requirements | | EN55032:2015, Class B |
| Electromagnetic compatibility of multimedia equipment – Immunity requirements | | EN55035:2017 |
| Low voltage power supplies, d.c. output Part 3: Electromagnetic compatibility | | EN IEC 61204-3:2018 |
| Information technology equipment - Immunity characteristics - Limits and methods of measurement | | EN55014-2:2015 |
| Electromagnetic compatibility of multimedia equipment – Emission Requirements | | EN55014-1:2017 |
| Limitations on the amount of electromagnetic interference allowed from digital and electronic devices | | FCC 47 CFR Part 15 Subpart B |
| ESD Electrostatic discharge immunity test | Air: ±2, 4 ,8kV Contact: ±4kV | IEC61000-4-2:2008 , Criteria A EN61000-4-2:2009, Criteria A |
| Radiated, radio-frequency, electromagnetic field immunity test | 3V/m: 80-1000MHz, 1800MHz, 2600MHz, 3500MHz, 5000MHz 1V/m: 2000-2700MHz | IEC/EN61000-4-3:2006 + A2:2010, Criteria A |
| Fast Transient and Burst Immunity | AC Port: ±1kV | IEC/EN61000-4-4:2012, Criteria A |
| Surge Immunity | AC Port: ±0.5, 1kV | IEC/EN61000-4-5:2014, Criteria A |
| Immunity to conducted disturbances, induced by radio-frequency fields | 3Vrms: 0.15-230MHz 3-1Vrms: 10-30MHz 1Vrms: 30-80MHz | IEC61000-4-6:2013/EN6100-4-6:2014, Criteria A IEC61000-4-6:2013/EN6100-4-6:2014, Criteria A IEC61000-4-6:2013/EN6100-4-6:2014, Criteria A |
| Voltage Dips and Interruptions | | IEC/EN61004-11:2004 |
| Limits of Harmonic Current Emissions | | IEC/EN61000-3-2:2019 |
| Limits of Voltage Fluctuations & Flicker | Clause 5 | EN61000-3-3:2013+A1 |

Specifications (measured @ Ta= 25°C, nom. Vin, full load and after warm-up unless otherwise stated)

DIMENSION AND PHYSICAL CHARACTERISTICS

| Parameter | Type | Value |
|-------------------|----------------------------------|--|
| Material | case/baseplate potting PCB | black plastic (UL94V-0) silicone (UL94V-0) FR4 (UL94V-0) |
| Dimension (LxWxH) | | 37.0 x 24.0 x 15.4mm |
| Weight | | 22.8g typ. |

Dimension Drawing (mm)

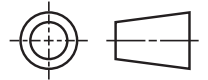
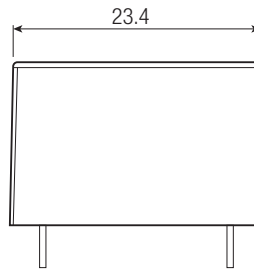
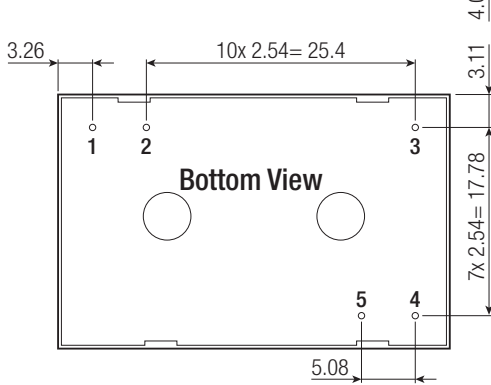
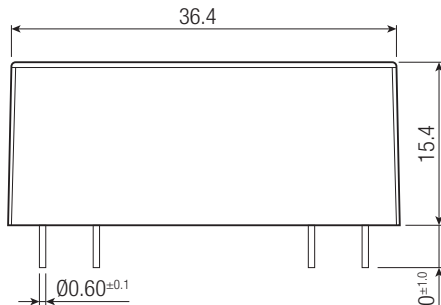
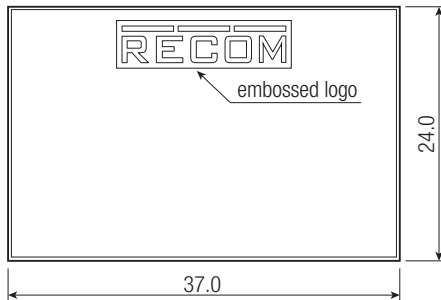

General tolerances according to ISO 2768-m (table for reference only)

| Dimension range | Tolerances |
|-----------------|------------|
| 0.5 - 6 mm | ±0.1 mm |
| 6 - 30 mm | ±0.2 mm |
| 30 - 120 mm | ±0.3 mm |
| 120 - 400 mm | ±0.5 mm |

Pinning Information

| Pin # | Single |
|-------|------------|
| 1 | VAC in (L) |
| 2 | VAC in (N) |
| 3 | NC |
| 4 | -Vout |
| 5 | +Vout |

NC= no connection

Recommended Footprint Details

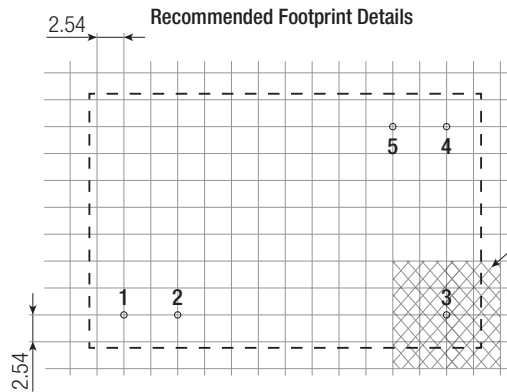

PACKAGING INFORMATION

| Parameter | Type | Value |
|-----------------------------|----------------|-----------------------|
| Packaging Dimension (LxWxH) | tube | 490.0 x 26.6 x 25.3mm |
| Packaging Quantity | | 12pcs |
| Storage Temperature Range | | -40°C to +85°C |
| Storage Humidity | non-condensing | 95% RH max. |

The product information and specifications may be subject to changes even without prior written notice. The product has been designed for various applications; its suitability lies in the responsibility of each customer. The products are not authorized for use in safety-critical applications without RECOM's explicit written consent. A safety-critical application is an application where a failure may reasonably be expected to endanger or cause loss of life, inflict bodily harm or damage property. The applicant shall indemnify and hold harmless RECOM, its affiliated companies and its representatives against any damage claims in connection with the unauthorized use of RECOM products in such safety-critical applications.