

Features

- 20W buck/boost converter with up to 4A output
- Input voltage can be higher, lower or same as output voltage

Power Module

- >90% efficiency from 100mA – 3000mA load
- 7µA standby power consumption
- Low profile, thermally enhanced 25pad LGA package



RBB10-2.0

2 Amp Single Output



Description

The RBB10-2.0 series is a 4A non-isolated buck/boost regulator power module where the input voltage can be higher, lower or same as output voltage. Transition from buck to boost mode is smooth without any interruption to the output. The compact DOSA-compatible footprint module has a low profile of only 3.75mm, but with an efficiency of up to 95%, the RBB10-2.0 can operate at full load in ambient temperatures as high as 85°C without forced air cooling. The package has 6-sided shielding for optimal EMC performance and excellent thermal management. Typical applications include USB voltage regenerators, 3.3V<->5V converters and supercapacitor or Li-Ion battery regulators.

Selection Guide

Part Number	Input Voltage Range [VDC]	Nom. Output Voltage [VDC]	Output Current max. [A]	Efficiency typ. [%]	Max. Capacitive Load ⁽¹⁾ [µF]
RBB10-2.0	2.3 - 5.5	5 (1.0 - 5.5)	4	96	42000

Notes:

Note1: Max. Cap Load is tested at nominal input and full resistive load



EN55032 compliant

Model Numbering

RBB10-2.0- _____ Packaging ⁽²⁾

Notes:

Note2: add suffix "-CT" for tube packaging for more details refer to "PACKAGING INFORMATION" without suffix, standard tape and reel packaging

Specifications (measured @ Ta= 25°C, 5Vin, 5Vout, 2A and after warm-up unless otherwise stated)

BASIC CHARACTERISTICS					
Parameter	Condition		Min.	Typ.	Max.
Internal Input Filter			capacitor		
Input Voltage Range ⁽³⁾			2.3VDC	5VDC	5.5VDC
Absolute Maximum Input Voltage			7VDC		
Undervoltage Lockout Threshold			1.6VDC	1.75VDC	2.0VDC
Undervoltage Lockout Hysteresis			65mV		
Input Current	Vin= 5VDC			2.3A	
	Vin= 3.6VDC			3.4A	
Quiescent Current	Vin= 5VDC			40µA	90µA
Internal Power Dissipation	Vin= 5VDC				0.9W
	Vin= 3.6VDC				1.8W
Output Current Range	refer to safe operating area		0A		4A
Output Voltage Trimming ⁽⁴⁾	see table or calculation		1.0VDC	5.0VDC	5.5VDC
Minimum Load			0%		
Start-up time	power up 2A	Vin= 5VDC		1.4ms	
		Vin= 3.6VDC		1.8ms	
	BUCK	Vin= 5VDC		700µs	
	BOOST	Vin= 3.6VDC		450µs	

continued on next page



<https://recom-power.com/rec-s-RBB10-2.0-EVM-1.html>

Specifications (measured @ Ta= 25°C, 5Vin, 5Vout, 2A and after warm-up unless otherwise stated)

Parameter	Condition		Min.	Typ.	Max.
Rise Time				400µs	
ON/OFF CTRL	nom. Vin= 5VDC	DC-DC ON DC-DC OFF	Open or $1.2V < V_{CTRL} < V_{in}$ Short or $-0.3V < V_{CTRL} < 0.4VDC$		
Input Current of CTRL Pad	nom. Vin= 5VDC	CTRL voltage = 0V		5µA	
Standby Current	nom. Vin= 5VDC	CTRL voltage = 0V		5.1µA	7µA
Internal Operating Frequency				2.55MHz	
Output Ripple and Noise ⁽⁶⁾	20MHz BW - 98Ω @ 100MHz + 22µF			15mVp-p	
Absolute Maximum Capacitive Load	<1 second start up	C _{ss} = 3700nF			42000µF
	<1 second start up	no C _{ss}			800µF

Notes:

- Note3: For detail information please refer to "Safe Operating Area" graph below
- Note4: For detail information please refer to trim table or calculation on page RBB-3
- Note5: Measurements are made with a 22µF MLCC across output (low ESR)

Efficiency vs. Load

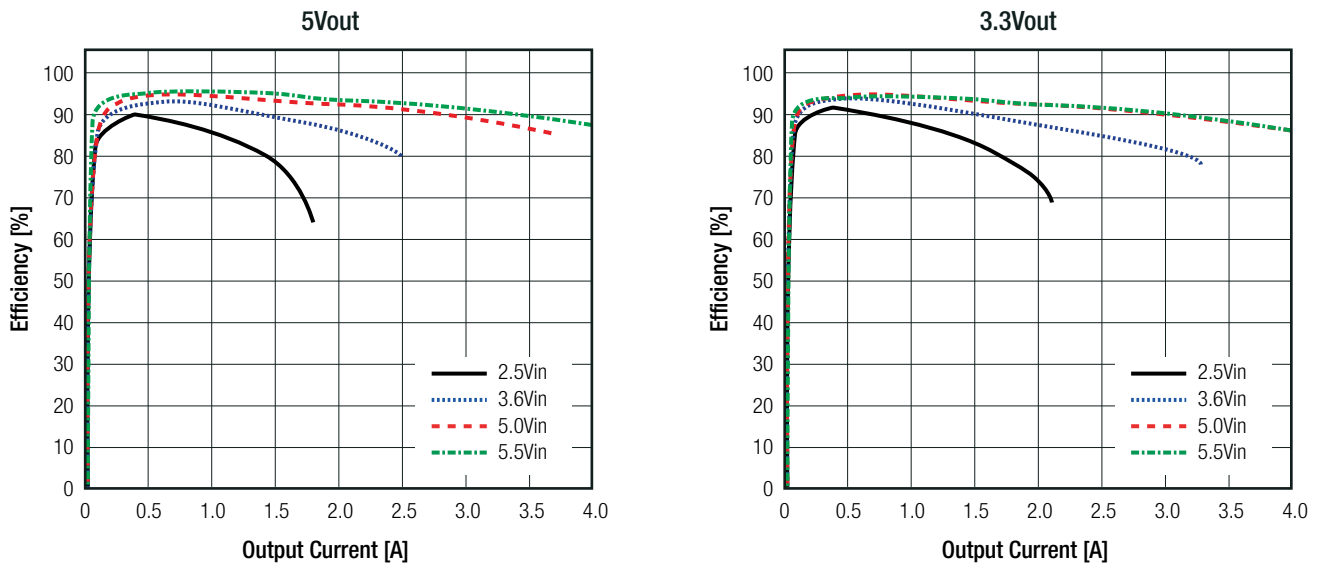

Safe Operating Area

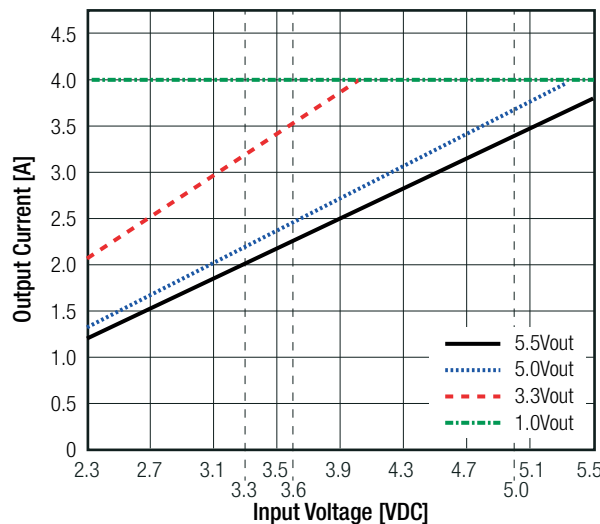

Specifications (measured @ Ta= 25°C, 5Vin, 5Vout, 2A and after warm-up unless otherwise stated)

OUTPUT VOLTAGE TRIMMING

The RBB10-2.0 series offers the feature of trimming the output voltage over a range between 1.0V and 5.5V by using external trim resistors. The values for trim resistors shown in trim tables below are according to standard E96 values; therefore, the specified voltage may slightly vary.

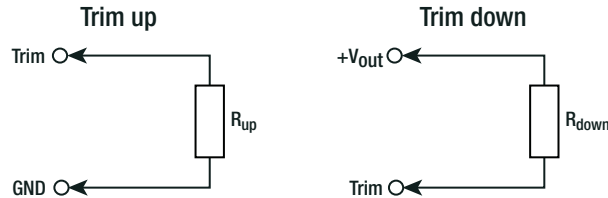

V_{out_nom} = nominal output voltage [VDC]
 V_{out_set} = trimmed output voltage [VDC]
 V_{ref} = reference voltage [VDC]
 R_{up} = trim up resistor [Ω]
 R_{down} = trim down resistor [Ω]
 R_1, R_2, R_3 = internal resistors [Ω]

V_{out_nom}	R_1	R_2	R_3	V_{ref}
5VDC	629k Ω	1k Ω	788k Ω	0.805

Calculation:

$$R_{up} = \left[\frac{R_1}{V_{out_set} - V_{nom}} \right] - R_2$$

$$R_{down} = \left[\frac{(V_{out_set} - V_{ref}) \times R_3}{V_{out_nom} - V_{out_set}} \right]$$

Practical Example RBB10-2.0:

$$R_{up} = \left[\frac{629k}{5.5 - 5.0} \right] - 1k = \underline{\underline{1M26\Omega}}$$

R_{up} according to E96 \approx 1M27 Ω

$$R_{down} = \left[\frac{(4.0 - 0.805) \times 788k}{5.0 - 4.0} \right] = \underline{\underline{2M52\Omega}}$$

R_{down} according to E96 \approx 2M55 Ω

RBB10-2.0

Trim up

V_{out_set} =	5.1	5.2	5.3	5.4	5.5	[VDC]
R_{up} (E96) \approx	6M34	3M16	2M10	1M58	1M27	[Ω]

Trim down

V_{out_set} =	4.5	4.0	3.5	3.3	3.0	2.5	2.0	1.8	1.5	1.0	[VDC]
R_{down} (E96) \approx	5M90	2M55	1M43	1M15	866k	536k	316k	243k	158k	38k3	[Ω]

REMOTE SENSE

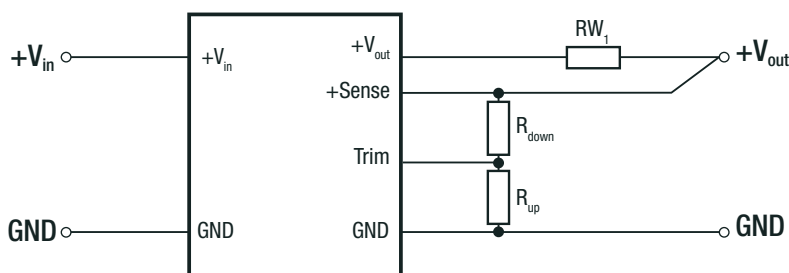

The output voltage can be adjusted via the trim and sense functions.

The maximum output voltage from Trim and Sense function combined is 5.5VDC. Derating may be required when using Trim and/or sense functions.

RW_1 ... wire losses +
 R_{up} ... trim up resistor
 R_{down} ... trim down resistor

Specifications (measured @ Ta= 25°C, 5Vin, 5Vout, 2A and after warm-up unless otherwise stated)

REGULATIONS			
Parameter	Condition		Value
Output Accuracy			±3.0% max.
Line Regulation	low line to high line, full load		1.0% typ. / ±3.0% max.
Load Regulation	0% to 100% load	PWM mode selected ⁽⁶⁾	0.5% max.
Transient Response	100% - 0% load step recovery time		200mV max. 500µs typ.
Notes:			
Note6: The RBB10 has the possibility to work in two regulation modes:			
<p>Powersave Mode (standard): This mode is the best for use at low loads to reduce power consumption and extend battery life. In this mode the internal power consumption is reduced by using burst mode for loads under 350mA and PWM for loads above 350mA. The drawback is a 1-3 % higher output voltage at low load than full load.</p> <p>Fixed PWM mode: In PWM mode the device accurately regulates the output voltage independently of the load current. The drawback is a higher internal power consumption and shorter battery life at lower loads. Pull down the Mode pad to GND to enter this mode.</p>			

PROTECTIONS			
Parameter	Condition		Value
Short Circuit Protection (SCP)	50mΩ		constant current limit
Short Circuit Input Current	nom. Vin= 2.3VDC		700mA typ.
Over Current Protection (OCP)	refer to safe operating area		220% - 240%, constant current mode
Over Temperature Protection (OTP)	case temperature (measured on tc point)	DC-DC OFF DC-DC ON	110°C, auto restart after cool down 100°C typ.

ENVIRONMENTAL			
Parameter	Condition		Value
Operating Temperature Range ⁽⁷⁾	@ natural convection 0.1m/s (refer to derating graph)	up to 4A load up to 2A load	-40°C to +85°C -40°C to +100°C
Maximum Case Temperature			+110°C
Temperature Coefficient	@ +65°C Tamb		0.02%/K
Thermal Impedance	0.1m/s, horizontal (Tcase to Tamb)		8K/W
Operating Altitude	with derating @ natural convection 0.1m/s (refer to altitude vs. load graph)		5000m
Operating Humidity	non-condensing		5% - 95% RH max.
Shock	MIL-STD-810G, Method 516.6, Procedure I		40g, 11ms, saw-tooth, 3 shocks ± per axis 3 axis; unit is operating
	MIL-STD-810G, Method 516.6, Procedure IV		drop on 50mm plywood on concrete 26 times from 1 meter
Temperature Cycling	MIL-STD-883F, Method 1010, Condition A		powered -50°C to +85°C, 300 cycles
Random Vibration	MIL-STD-810G, Method 514.6, Procedure I, Category 24		Category 24 - Figure 514.6E-1 - power spectral density = 0.04g ² /Hz at 20Hz –1000Hz, -6dB/Octave at 1000Hz – 2000Hz, 60 minutes x 3 axis; unit is operating during tests
MTBF	according to MIL-HDBK-217F, G.B.	+25°C +85°C	2200 x 10 ³ hours 400 x 10 ³ hours
Notes:			
Note7: tested with a eurocard 160x100mm 70µm copper, 4 layer			
continued on next page			

Specifications (measured @ Ta= 25°C, 5Vin, 5Vout, 2A and after warm-up unless otherwise stated)

Derating Graph ⁽⁷⁾

(@ chamber and natural convection 0.1m/s)

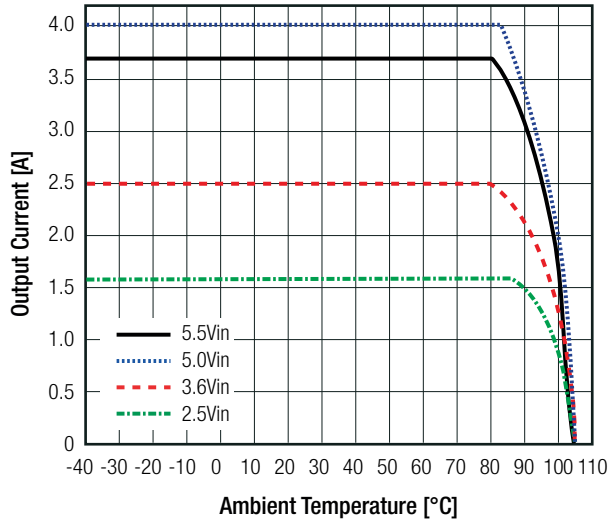

Operating Altitude vs Load

(@ chamber and natural convection 0.1m/s)

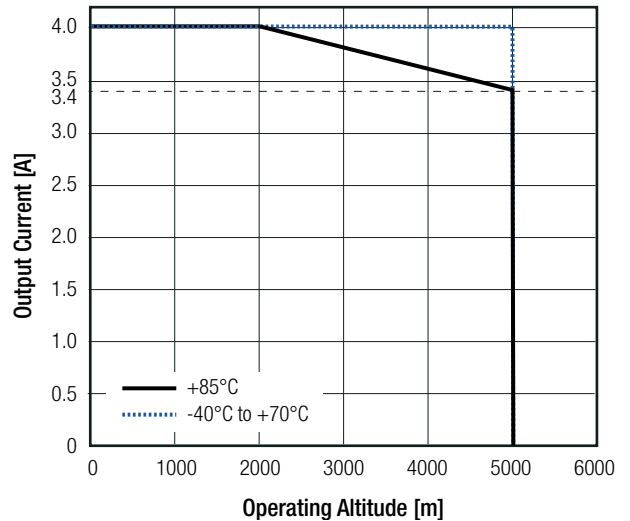

SAFETY AND CERTIFICATIONS

Certificate Type (Safety)	Report / File Number	Standard
RoHS 2+		RoHS 2011/65/EU + AM2015/863

EMC Compliance	Condition	Standard / Criterion
Electromagnetic compatibility of multimedia equipment - Emission requirements	with external components	EN55032, Class B
Information technology equipment - Immunity characteristics - Limits and methods of measurement		EN55024:2010+A1:2015

EMC Filtering Suggestions according to EN55032

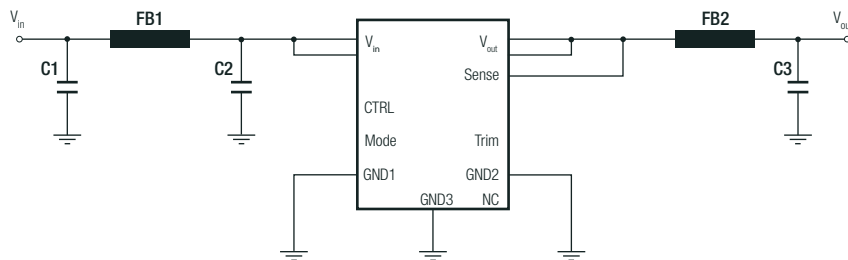

Component List Class B

C1	C2	FB1	FB2	C3
10µF 25V X7R	10µF 25V X7R	WE ref.: 742792510	WE ref.: 7427932	22µF 10V 7XR

DIMENSION AND PHYSICAL CHARACTERISTICS

Parameter	Type	Value
Material	case	metal
	PCB	FR4, (UL94 V-0)
	solder pads	copper with electrolytic nickel-gold
Dimension (LxWxH)		12.19 x 12.19 x 3.75mm
Weight		1.1g typ.

continued on next page

Specifications (measured @ Ta= 25°C, 5Vin, 5Vout, 2A and after warm-up unless otherwise stated)

Dimension Drawing (mm)

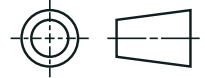
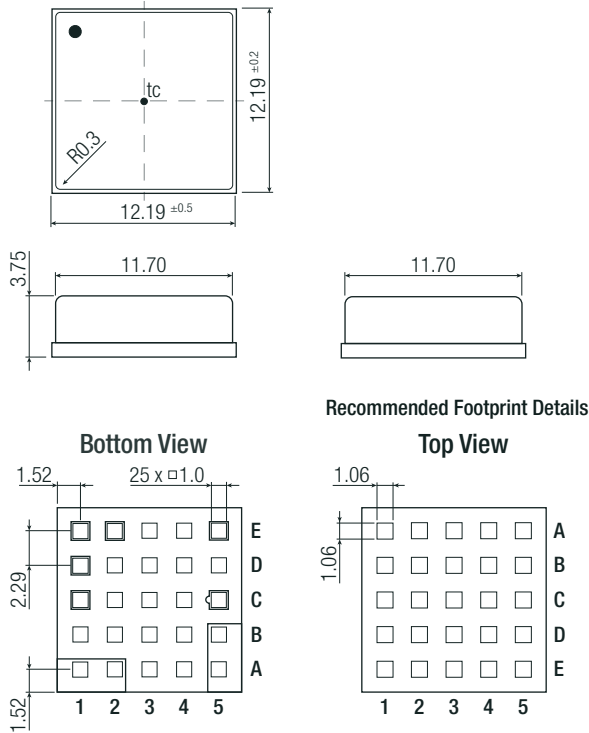

Pinning information

Pad #	Function	Description
A1, A2	Vin	Positive input voltage with respect to GND. Connect to a Vin plane for enhanced thermal performance
C1	CTRL	High active: pull to GND to disable the device. Pull high or leave open to enable the device
A5, B5	Vout	Positive output voltage. Connect to a Vout plane for enhanced thermal performance
C5	Sense	Connect this pad to the load or directly to Vout. This pad must not be left floating
E5	Trim	Used to set the output voltage between 0.9V and 6V
E1	NC	Not connected
E2	Mode	Refer to note 6 on page RBB-4
D1	NC	Not connected
A3, A4, B1, B2, B3, B4, C2, C3, C4, D2, D3, D4, D5, E3, E4	GND	Negative input voltage. Connect to GND plane(s) for enhanced thermal performance

tc = case temperature measuring point
Pad tolerance= ±0.05mm
Case tolerance= ±0.25mm

BLOCKDIAGRAM

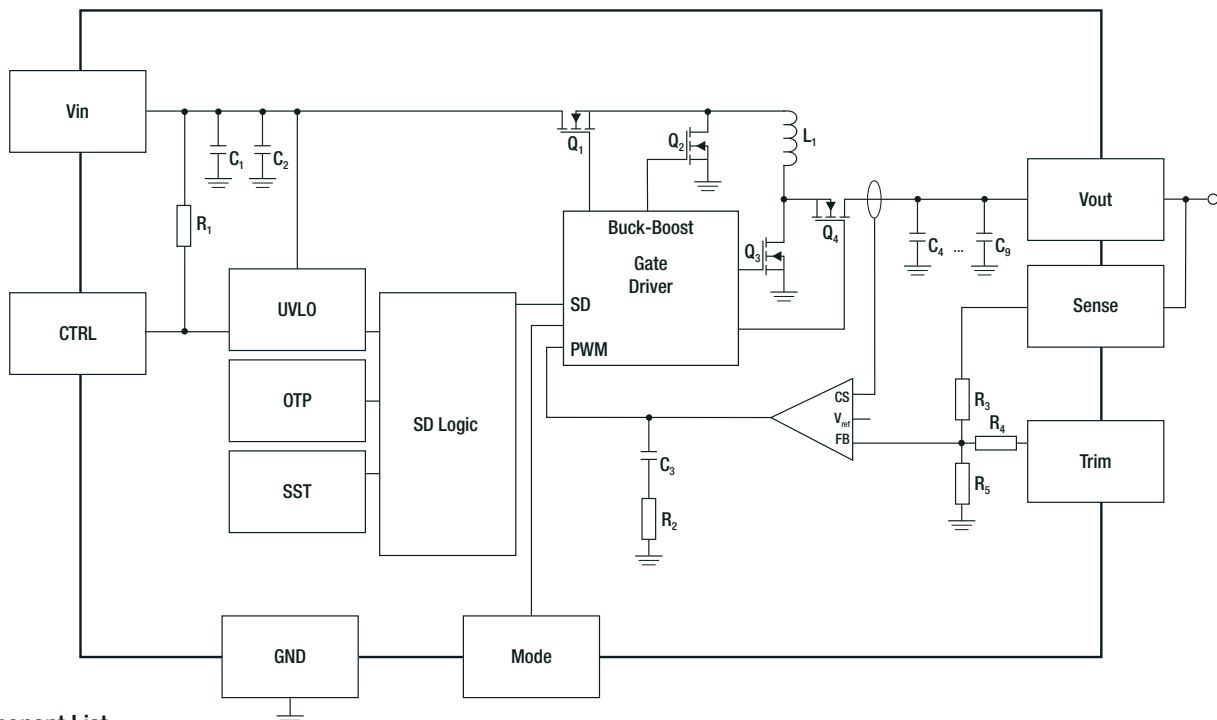

Component List

C1, C2	L1	C4 - C9	R3	R4	R5
10µF 2pcs. in parallel	1µH	10µF 6pcs. in parallel	787kΩ	1kΩ	150kΩ

Specifications (measured @ Ta= 25°C, 5V_{in}, 5V_{out}, 2A and after warm-up unless otherwise stated)

PACKAGING INFORMATION

Parameter	Type	Value
Packaging Dimension (LxWxH)	tape and reel	330.2 x 330.2 x 30.4mm
	tape and reel (carton)	365.0 x 365.0 x 55.0mm
	tube ("-CT")	530.0 x 30.3 x 19.2mm
Packaging Quantity	tape and reel	500pcs
	tube ("-CT")	30pcs
Tape Width		24mm
Storage Temperature Range		-55°C to +125°C
Storage Humidity	non-condensing	95% RH max.

The product information and specifications may be subject to changes even without prior written notice. The product has been designed for various applications; its suitability lies in the responsibility of each customer. The products are not authorized for use in safety-critical applications without RECOM's explicit written consent. A safety-critical application is an application where a failure may reasonably be expected to endanger or cause loss of life, inflict bodily harm or damage property. The applicant shall indemnify and hold harmless RECOM, its affiliated companies and its representatives against any damage claims in connection with the unauthorized use of RECOM products in such safety-critical applications.