

Features

Regulated Converters

- 1.6kVDC, 2kVDC, 4kVDC or 6kVDC isolation
- Industry standard 3W DIP24 or SMD package
- Feedback regulated output
- Continuous short circuit protection
- Wide 2:1 or 4:1 input
- 3 case styles
- CTRL pin option ("A" pinning only)
- Efficiency up to 86%



REC3-RW(Z)

3 Watt
DIP24 or
SMD Case
Single and Dual

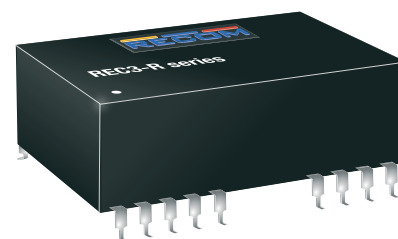

IEC60950-1 certified
 UL60950-1 certified
 CAN/CSA-C22.2 No. 60950-1-03 certified
 EN55032 compliant

Description

Besides the standard isolation of 2kVDC/1s, this series offers options of 4kVDC/1s (= „/H4“) or 6kVDC (=“/H6“) making it suitable for sophisticated industrial applications. Packaging can be either DIP-24 plastic or 5-side-shielded DIP24 metal case (=option „/M“) as well as SMD pinning (= option „/SMD“). For all the above variants, 2 industry-standard pinout (= option „/A“ or „/C“) are available, and B pinning is available with 1.6kVDC/1s isolation. ON/OFF CTRL is possible with the /CTRL option (A pinning only). The converters can deliver 140% rated power for short periods of time to cope with applications with large capacitive loads or high start up currents.

Selection Guide

Part Number	Input Voltage Range ⁽¹⁾ [VDC]	Output Voltage [VDC]	Output Current [mA]	Efficiency typ. ⁽²⁾ [%]	max. Capacitive Load ⁽³⁾ [µF]
REC3-xx3.3SRW	4.5-9, 9-18, 18-36, 36-72	3.3	900	66-76	4700
REC3-xx05SRW	4.5-9, 9-18, 18-36, 36-72	5	600	71-79	4700
REC3-xx09SRW	4.5-9, 9-18, 18-36, 36-72	9	330	74-83	3300
REC3-xx12SRW	4.5-9, 9-18, 18-36, 36-72	12	250	75-85	2200
REC3-xx15SRW	4.5-9, 9-18, 18-36, 36-72	15	200	75-86	2200
REC3-xx05DRW	4.5-9, 9-18, 18-36, 36-72	±5	±300	74-83	±2200
REC3-xx09DRW	4.5-9, 9-18, 18-36, 36-72	±9	±165	74-83	±1000
REC3-xx12DRW	4.5-9, 9-18, 18-36, 36-72	±12	±125	75-85	±1000
REC3-xx15DRW	4.5-9, 9-18, 18-36, 36-72	±15	±100	75-86	±1000
REC3-xx3.3SRWZ	9-36, 18-72	3.3	900	77-79	4700
REC3-xx05SRWZ	9-36, 18-72	5	600	78-80	4700
REC3-xx09SRWZ	9-36, 18-72	9	330	80-83	3300
REC3-xx12SRWZ	9-36, 18-72	12	250	83-85	2200
REC3-xx15SRWZ	9-36, 18-72	15	200	83-85	2200
REC3-xx05DRWZ	9-36, 18-72	±5	±300	77-80	±2200
REC3-xx09DRWZ	9-36, 18-72	±9	±165	77-80	±1000
REC3-xx12DRWZ	9-36, 18-72	±12	±125	83-85	±1000
REC3-xx15DRWZ	9-36, 18-72	±15	±100	83-85	±1000

Notes:

Note1: Refer to "Input Voltage Range"

Note2: Efficiency is tested at nominal input and full load at +25°C ambient

Note3: Maximum capacitive load is defined as the capacitive load that will allow start up in under 1 second without damage to the converter

PREFERRED ALTERNATIVES

For new medical applications:

REM3.5E



Model Numbering

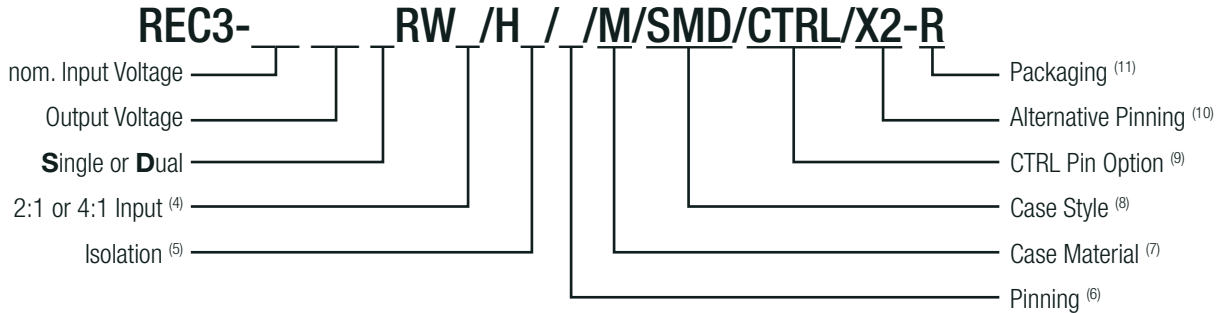

Notes:

- Note4: add suffix „Z” for 4:1 Input Voltage (24= 9-36VDC or 48= 18-72VDC)
 Note5: add suffix „/H” = 1.6kVDC/1s isolation (B pinning only)
 „/H2” = 2kVDC/1s isolation (A, A/X2 or C pinning available only)
 „/H4” = 4kVDC/1s isolation (A, A/X2 or C pinning available only)
 „/H6” = 6kVDC/1s isolation (A, A/X2 or C pinning available only)
 Note6: „/A” & „/A/X2”= A pinning; „/B”= B pinning or „/C” for C pinning.
 „/B” Pinning is restricted to 1.6kV isolation due to the closeness of the input and output pins.
 For more details please refer to **”DIMENSION AND PHYSICAL CHARACTERISTICS”**
 Note7: add suffix „/M” for 5-side-shielded metal case, without suffix non-conductive black plastic case
 Note8: add suffix „/SMD” for SMD package, without suffix = standard DIP24 THT package. (If the options „/M” and „/SMD” are combined, the maximum allowed isolation voltage is 2kVDC/1s because of the shorter distance between pins and the metal case; DIP24 THT case and SMD plastic case are not affected and offer the full isolation barriers of 2kVDC/1s through to 6kVDC/1s
 Note9: add „/CTRL” for control pin option (A pinning only). If CTRL option is not chosen, Pin 1 will be absent.
 Note10: add suffix „/X2” for alternative pinout (THT package with A-pinning and single output only)
 Note11: add suffix „-R” for tape and reel packaging (available for SMD case style only)
 without suffix = standard tube packaging

Ordering Examples:

REC3-0505SRW/H4/A/M/CTRL	4.5-9Vin	5Vout	Single Output	2:1 input	4kVDC/1s isolation	A pinning	metal case	with CTRL Pin	THT	tube packaging
REC3-2412DRWZ/H2/C/SMD-R	9-36Vin	±12Vout	Dual Output	4:1 input	2kVDC/1s isolation	C pinning	plastic case	no CTRL function	SMD	tape and reel packaging
REC3-1212SRWZ/H/B/M	9-36Vin	12Vout	Single Output	4:1 input	6kVDC/1s isolation	B pinning	metal case	no CTRL Pin	THT	tube packaging
REC3-1215DRW/H/B/M/SMD-R	9-18Vin	±15Vout	Dual Output	2:1 input	1.6kVDC/1s isolation	B pinning	metal case	no CTRL function	SMD	tape and reel packaging

Specifications (measured @ Ta= 25°C, nom. Vin, full load and after warm-up unless otherwise stated)

BASIC CHARACTERISTICS					
Parameter	Condition		Min.	Typ.	Max.
Internal Input Filter			Pi Network		
Input Voltage Range	2:1 Input	nom. Vin= 5VDC	4.5VDC		9VDC
		nom. Vin= 12VDC	9VDC		18VDC
	4:1 Input („Z”)	nom. Vin= 24VDC	18VDC		36VDC
		nom. Vin= 48VDC	36VDC		72VDC
No Load Power Consumption					300mW
Minimum Load ⁽¹²⁾			10%		
ON/OFF CTRL ⁽¹³⁾	DC-DC ON DC-DC OFF		Open or 0VDC < V _{CTRL} < 1.2VDC 2.2VDC < V _{CTRL} < 12VDC		
Internal Operating Frequency	2:1 Input		90kHz		150kHz
	4:1 Input		120kHz		180kHz
Output Ripple and Noise ⁽¹⁴⁾	20MHz BW				50mVp-p
Notes:					
Note12: Operation below 10% load will not harm the converter, but specifications may not be met					
Note13: “A”-pinning only. Refer to ”ON/OFF CTRL (A pinning only)”					
Note14: Measurements are made with a 0.1µF MLCC across output. (low ESR)					

continued on next page

Specifications (measured @ Ta= 25°C, nom. Vin, full load and after warm-up unless otherwise stated)

Efficiency vs. Load

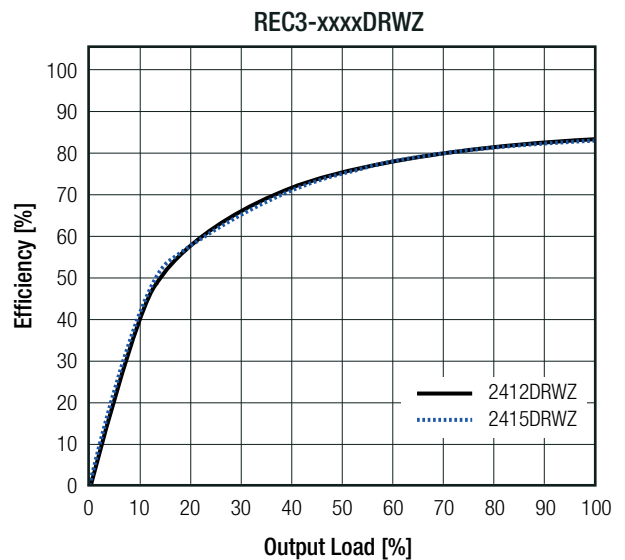
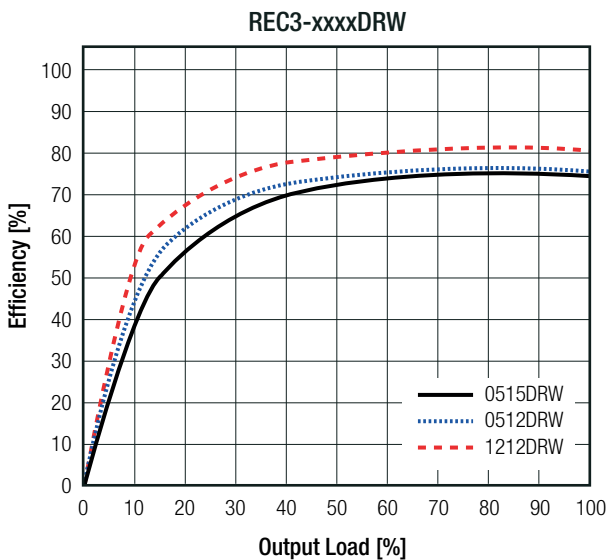
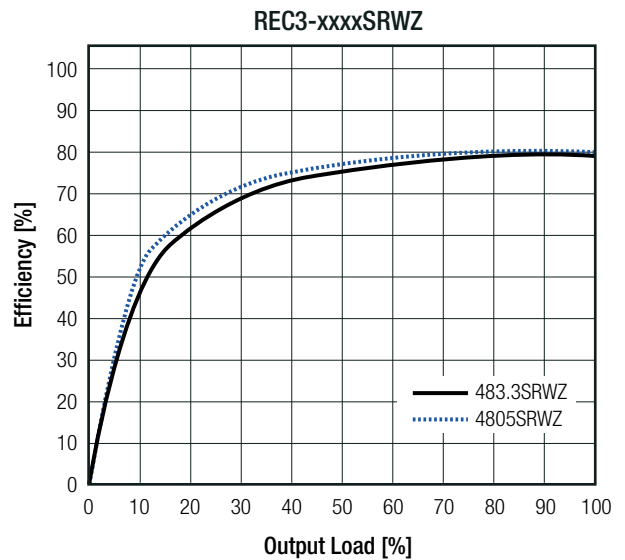
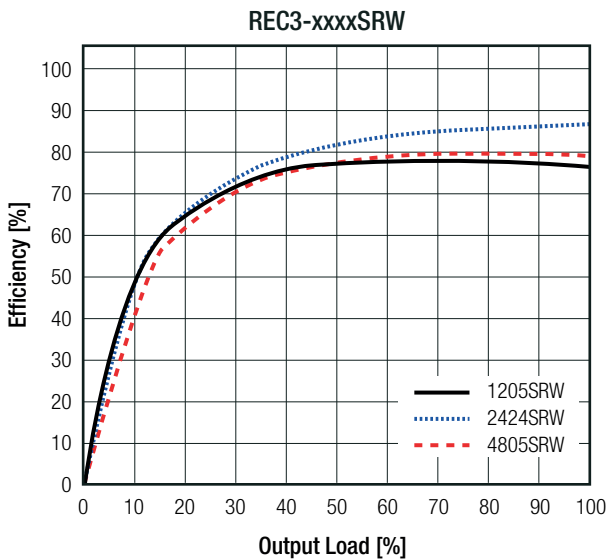
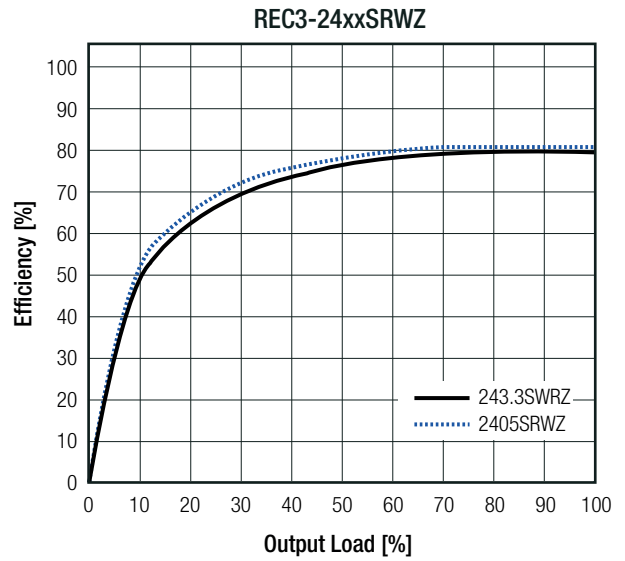
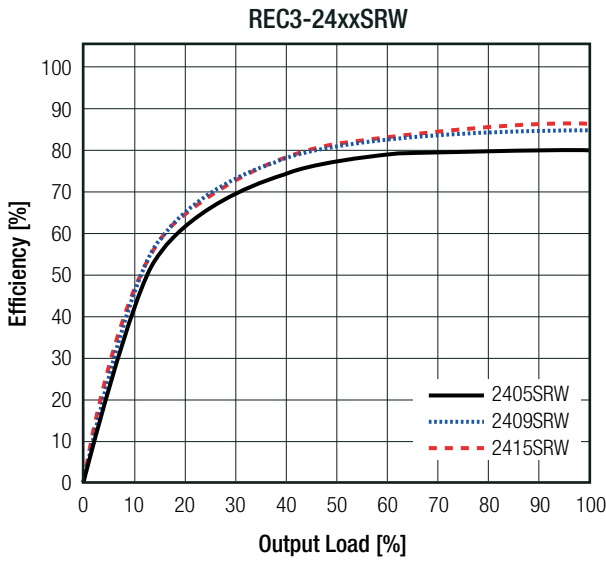

Specifications (measured @ Ta= 25°C, nom. Vin, full load and after warm-up unless otherwise stated)

ON/OFF CTRL (A pinning only)

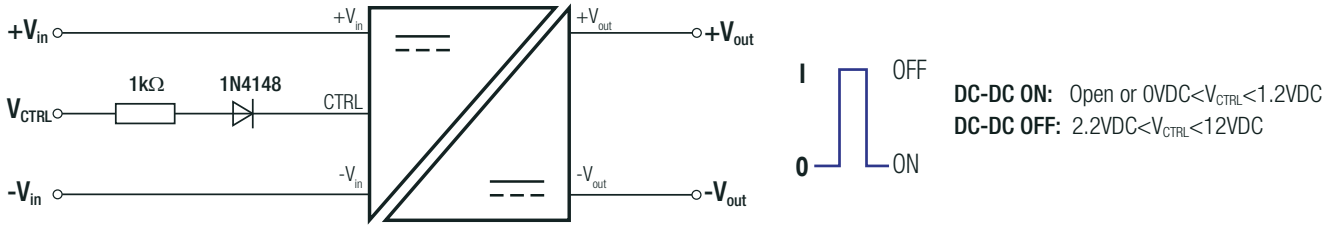

REGULATIONS

Parameter	Condition	Value
Output Accuracy		±2.0% max.
Line Regulation	low line to high line, full load	±0.4% max.
Load Regulation ⁽¹⁵⁾	20% to 100% load	0.6% max.

Notes:

Note15: Operation below 20% load will not harm the converter, but specifications may not be met.

PROTECTIONS

Parameter	Type	Value
Short Circuit Protection (SCP) ⁽¹⁶⁾	below 100mΩ	continuous, auto recovery
Isolation Voltage ⁽¹⁷⁾	with suffix "/H"	tested for 1 second rated for 1 minute 1.6kVDC 500VAC/ 60Hz
	with suffix "/H2"	tested for 1 second rated for 1 minute 2kVDC 1kVAC/ 60Hz
	with suffix "/H4"	tested for 1 second rated for 1 minute 4kVDC 2kVAC/ 60Hz
	with suffix "/H6"	tested for 1 second rated for 1 minute 6kVDC 3kVAC/ 60Hz
Isolation Resistance		1GΩ min.
Isolation Capacitance	2:1 Input	20pF min. / 60pF max.
	4:1 Input	40pF min. / 80pF max.

Notes:

Note16: Max. ambient Temperature= +60°C during the short circuit conditions

Note17: For repeat Hi-Pot testing, reduce the time and/or the test voltage

ENVIRONMENTAL

Parameter	Condition	Value	
Operating Temperature Range	with derating @ free air convection (refer to "Derating Graph")	-40°C to +105°C	
Thermal Impedance	plastic case	20K/W	
	metal case	12K/W	
Operating Altitude	according to 60601-1	3000m	
Operating Humidity	non-condensing	95% RH max.	
Pollution Degree		PD2	
MTBF	according to MIL-HDBK-217F, G.B.	+25°C	1043 x 10 ³ hours
		+85°C	186 x 10 ³ hours

continued on next page

Specifications (measured @ $T_a = 25^\circ\text{C}$, nom. V_{in} , full load and after warm-up unless otherwise stated)

Derating Graph

(@ Chamber and free air convection 0.1 m/s)

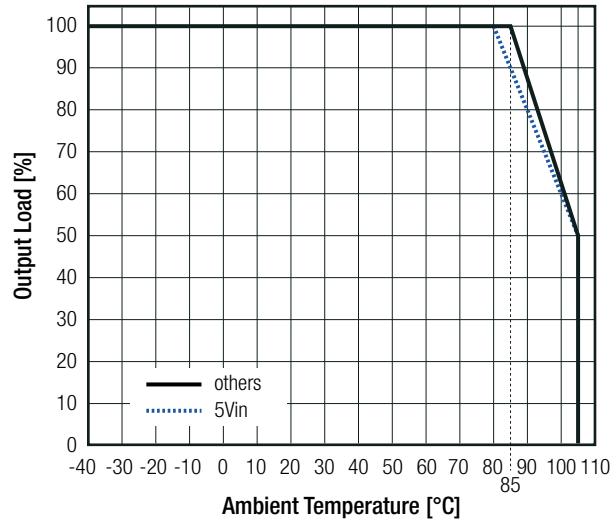

SAFETY AND CERTIFICATIONS

Certificate Type (Safety)	Report / File Number	Standard
Information Technology Equipment, General Requirements for Safety	E358085-A5	UL60950-1, 1st Edition, 2007 CAN/CSA-C22.2 No. 60950-1-03, 1st Edition, 2006
Information Technology Equipment, General Requirements for Safety (LVD)	LVD1605077-10	IEC60950-1:2005, 2nd Edition + A2:2013 EN60950-1:2006 + A2:2013
Medical Electrical Equipment Part 1: General Requirements for Basic Safety and Essential Performance	SPC1006048	IEC60601-1:1988 + A2:1995 EN60601-1:1990 + A13 :1996
EAC	RU-AT.49.09571	TP TC 004/2011
RoHS2		RoHS-2011/65/EU + AM-2015/863

EMC Compliance	Condition	Standard / Criterion
Electromagnetic compatibility of multimedia equipment - Emission requirements ⁽¹⁸⁾	with external filter (see filter suggestion below)	EN55032, Class A/B

EMC Filtering Suggestions according to EN55032

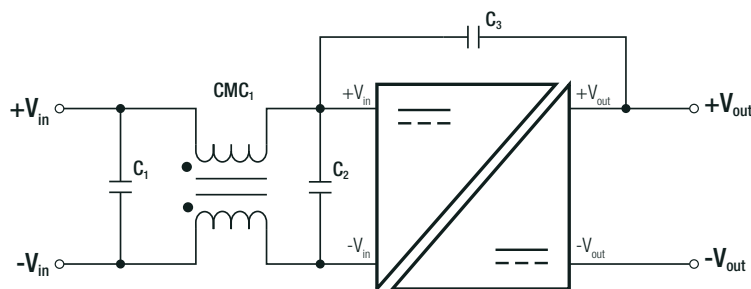

Component List Class A

MODEL	C1	C2	C3	CMC1
REC3-0505SRW/H4	N/A	10µF/100V MLCC	N/A	N/A
REC3-1215SRW/H4			150pF	
REC3-2412SRW/H4			330pF	
REC3-4805SRW/H6			470pF	

Component List Class B

MODEL	C1	C2	C3	CMC1
REC3-0505SRW/H4	10µF/100V MLCC	10µF/100V MLCC	N/A	250µH
REC3-1215SRW/H4			1nF	
REC3-2412SRW/H4				470µH
REC3-4805SRW/H6				

Notes:

Note18: Filter suggestions are valid for indicated part numbers only. For other part numbers, please contact Recom tech support for advice

Specifications (measured @ Ta= 25°C, nom. Vin, full load and after warm-up unless otherwise stated)

DIMENSION AND PHYSICAL CHARACTERISTICS

Parameter	Type		Value
Material	plastic case		non-conductive black plastic, (UL94 V-0)
	metal case		nickel plated copper
Dimension (LxWxH)	DIP24	plastic case	31.8 x 20.3 x 10.2mm
		metal case	32.0 x 20.3 x 10.5mm
	SMD	plastic case	31.8 x 20.3 x 11.2mm
		metal case	32.0 x 20.3 x 11.2mm
Weight			13g typ.

Dimension Drawing DIP24 plastic case (mm)

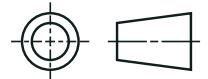

„A“ Pinning (/H2, /H4, /H6)

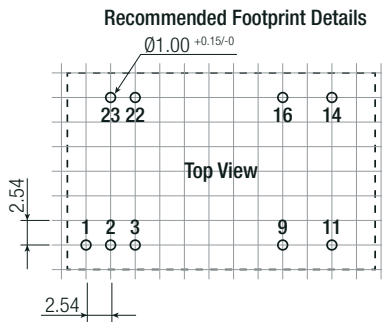
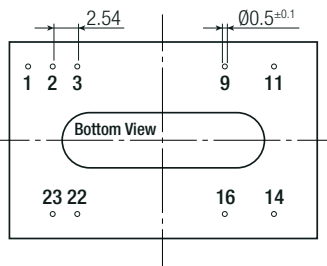
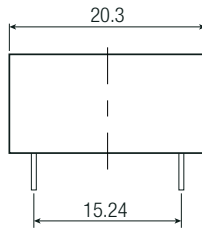
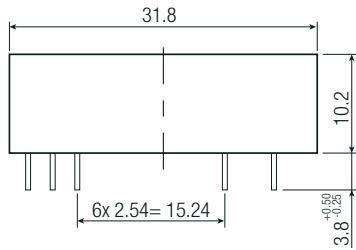

„A“ Pinning information (/H2, /H4, /H6)

Pin #	Single	Single/X2	Dual
1 (option)	CTRL ⁽⁹⁾	CTRL ⁽⁹⁾	CTRL ⁽⁹⁾
2,3	-Vin	-Vin	-Vin
9	NC	no pin	Com
11	NC	NC	-Vout
14	+Vout	+Vout	+Vout
16	-Vout	-Vout	Com
22,23	+Vin	+Vin	+Vin

NC= No Connection

Tolerance: xx.x= ±0.5mm

xx.xx= ±0.25mm

„C“ Pinning (/H2, /H4, /H6)

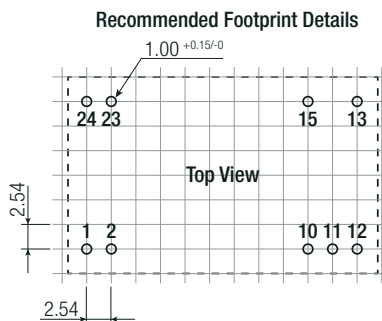
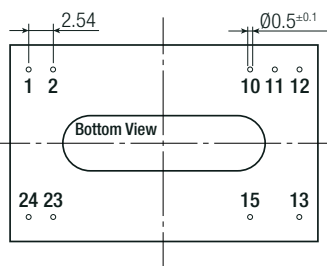
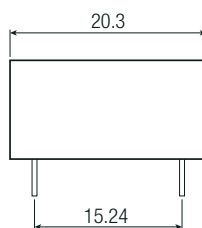
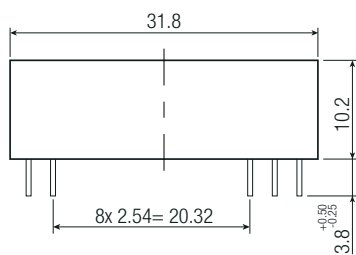

„C“ Pinning information (/H2, /H4, /H6)

Pin #	Single	Dual
1,2	+Vin	+Vin
10,11	NC	Com
12	-Vout	NC
13	+Vout	-Vout
15	NC	+Vout
23,24	-Vin	-Vin

NC= No Connection

Tolerance: xx.x= ±0.5mm

xx.xx= ±0.25mm

continued on next page

Specifications (measured @ Ta= 25°C, nom. Vin, full load and after warm-up unless otherwise stated)

„B“ Pinning (/H only)

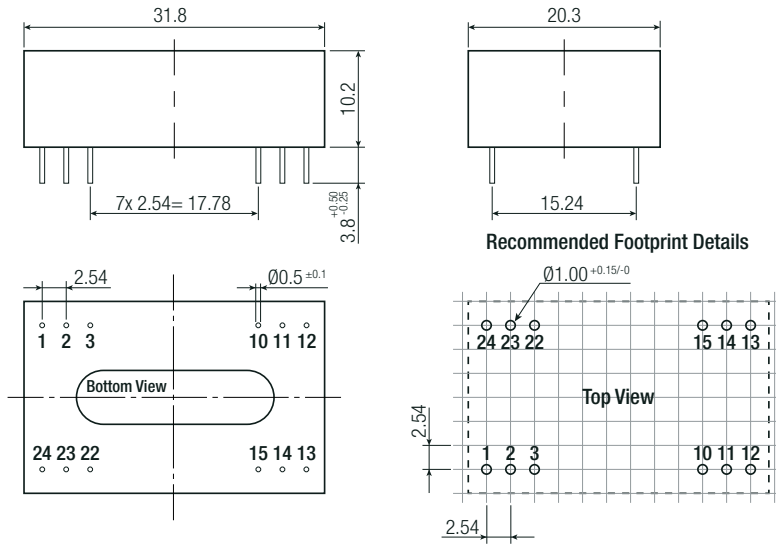

„B“ Pinning information (/H only)

Pin #	Single	Dual
1	+Vin	+Vin
2	no pin	-Vout
3	no pin	Com
10	-Vout	Com
11,14	+Vout	+Vout
12,13	-Vin	-Vin
15	-Vout	Com
22	no pin	Com
23	no pin	-Vout
24	+Vin	+Vin

NC= No Connection
Tolerance: xx.x= ±0.5mm
xx.xx= ±0.25mm

SMD plastic case ⁽⁹⁾

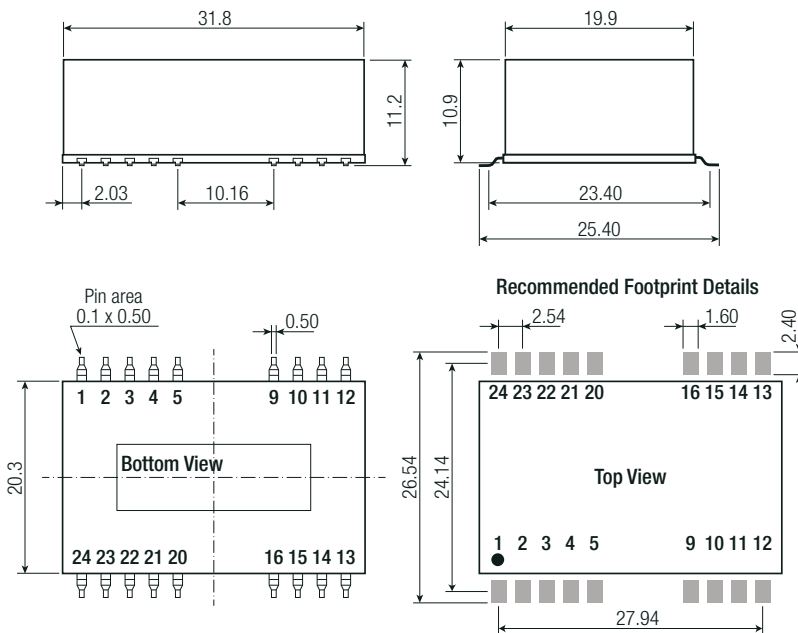

„A“ Pinning information

Pin #	Single	Dual
1 (option)	CTRL	CTRL
2,3	-Vin	-Vin
4,5	NC	NC
9	NC	Com
10,12,13,15	NC	NC
11	NC	-Vout
14	+Vout	+Vout
16	-Vout	Com
20,21,24	NC	NC
22,23	+Vin	+Vin

NC= No Connection
Tolerance: xx.x= ±0.5mm
xx.xx= ±0.25mm

„C“ Pinning information

Pin #	Single	Dual
1,2	+Vin	+Vin
3,4,5,9	NC	NC
10,11	NC	Com
12	-Vout	NC
13	+Vout	-Vout
14	NC	NC
15	NC	+Vout
16,20,21,22	NC	NC
23,24	-Vin	-Vin

NC= No Connection
Tolerance: xx.x= ±0.5mm
xx.xx= ±0.25mm

„B“ Pinning information

Pin #	Single	Dual
1	+Vin	+Vin
2	NC	-Vout
3	NC	Com
4,5,9	NC	NC
10	-Vout	Com
11	+Vout	+Vout
12,13	-Vin	-Vin
14	+Vout	+Vout
15	-Vout	Com
16,20,21	NC	NC
22	NC	Com
23	NC	-Vout
24	+Vin	+Vin

NC= No Connection
Tolerance: xx.x= ±0.5mm
xx.xx= ±0.25mm

continued on next page

Specifications (measured @ Ta= 25°C, nom. Vin, full load and after warm-up unless otherwise stated)

Notes:

Note19: All models with plastic case have embossed logo. See top view below:

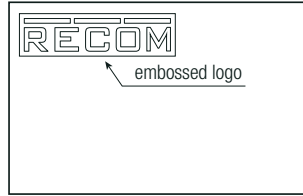

Dimension Drawing DIP24 metal case (mm)

“A” Pinning (/H2, /H4, /H6)

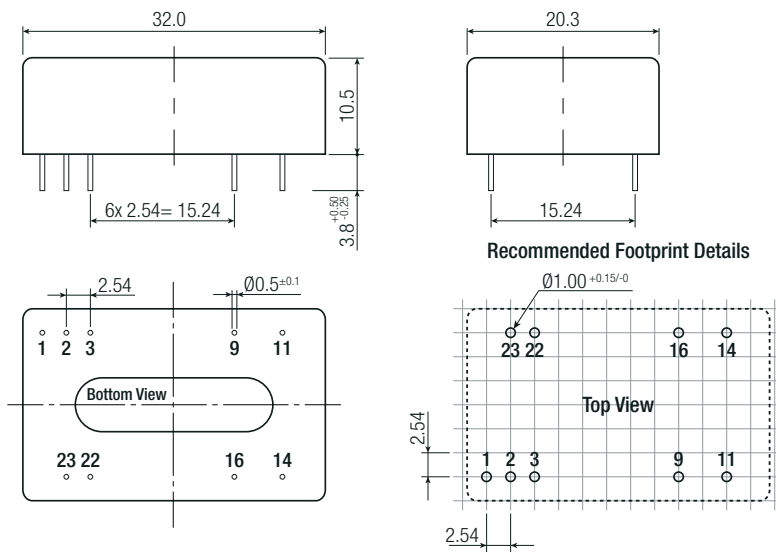

„A“ Pinning information

Pin #	Single	Single/X2	Dual
1 (option)	CTRL ⁽⁹⁾	CTRL ⁽⁹⁾	CTRL ⁽⁹⁾
2,3	-Vin	-Vin	-Vin
9	NC	no pin	Com
11	NC	NC	-Vout
14	+Vout	+Vout	+Vout
16	-Vout	-Vout	Com
22,23	+Vin	+Vin	+Vin

NC= No Connection
Tolerance: xx.x= ±0.5mm
xx.xx= ±0.25mm

“C” Pinning (/H2, /H4, /H6)

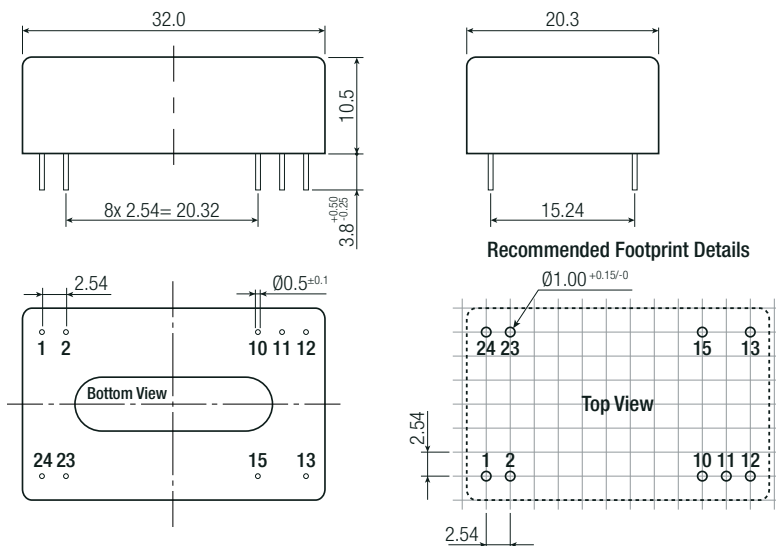

„C“ Pinning information

Pin #	Single	Dual
1,2	+Vin	+Vin
10,11	NC	Com
12	-Vout	NC
13	+Vout	-Vout
15	NC	+Vout
23,24	-Vin	-Vin

NC= No Connection
Tolerance: xx.x= ±0.5mm
xx.xx= ±0.25mm

continued on next page

Specifications (measured @ Ta= 25°C, nom. Vin, full load and after warm-up unless otherwise stated)

„B“ Pinning (/H only)

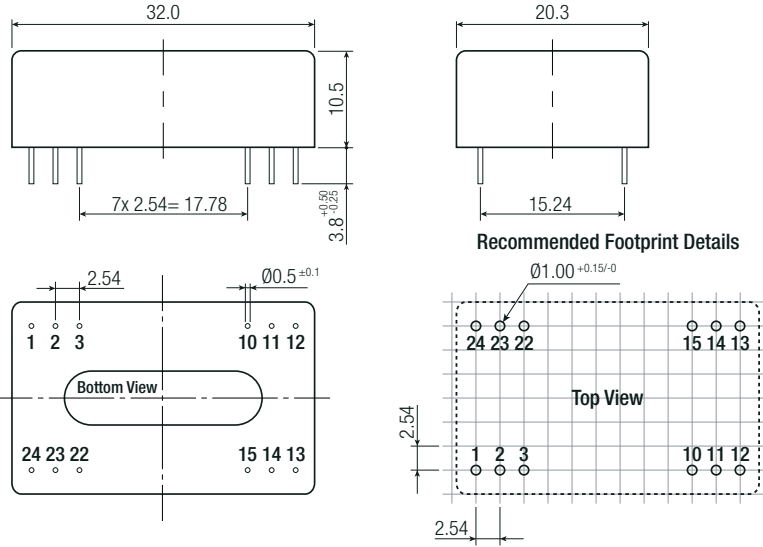

„B“ Pinning information

Pin #	Single	Dual
1	+Vin	+Vin
2	no pin	-Vout
3	no pin	Com
10	-Vout	Com
11,14	+Vout	+Vout
12,13	-Vin	-Vin
15	-Vout	Com
22	no pin	Com
23	no pin	-Vout
24	+Vin	+Vin

NC= No Connection
Tolerance: xx.x= ±0.5mm
xx.xx= ±0.25mm

SMD metal case ⁽⁹⁾

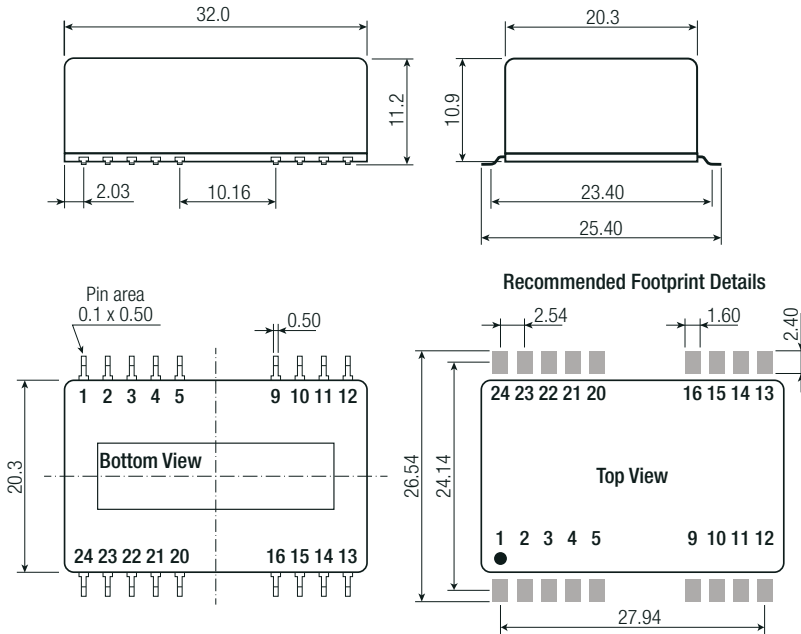

„A“ Pinning information

Pin #	Single	Dual
1 (option)	CTRL	CTRL
2,3	-Vin	-Vin
4,5	NC	NC
9	NC	Com
10,12,13,15	NC	NC
11	NC	-Vout
14	+Vout	+Vout
16	-Vout	Com
20,21,24	NC	NC
22,23	+Vin	+Vin

NC= No Connection
Tolerance: xx.x= ±0.5mm
xx.xx= ±0.25mm

„C“ Pinning information

Pin #	Single	Dual
1,2	+Vin	+Vin
3,4,5,9	NC	NC
10,11	NC	Com
12	-Vout	NC
13	+Vout	-Vout
14	NC	NC
15	NC	+Vout
16,20,21,22	NC	NC
23,24	-Vin	-Vin

NC= No Connection
Tolerance: xx.x= ±0.5mm
xx.xx= ±0.25mm

„B“ Pinning information

Pin #	Single	Dual
1	+Vin	+Vin
2	NC	-Vout
3	NC	Com
4,5,9	NC	NC
10	-Vout	Com
11	+Vout	+Vout
12,13	-Vin	-Vin
14	+Vout	+Vout
15	-Vout	Com
16,20,21	NC	NC
22	NC	Com
23	NC	-Vout
24	+Vin	+Vin

NC= No Connection
Tolerance: xx.x= ±0.5mm
xx.xx= ±0.25mm

Specifications (measured @ Ta= 25°C, nom. Vin, full load and after warm-up unless otherwise stated)

PACKAGING INFORMATION			
Parameter	Type		Value
Packaging Dimension (LxWxH)	DIP24	tube	530.0 x 23.0 x 19.0mm
	SMD	tube	530.0 x 32.0 x 19.0mm
		tape and reel (carton)	355.0 x 342.0 x 70.0mm
Packaging Quantity	tube		15pcs
	tape and reel		100pcs
Tape Width			44mm
Storage Temperature Range			-55°C to +125°C
Storage Humidity	non-condensing		95% RH max.

The product information and specifications may be subject to changes even without prior written notice. The product has been designed for various applications; its suitability lies in the responsibility of each customer. The products are not authorized for use in safety-critical applications without RECOM's explicit written consent. A safety-critical application is an application where a failure may reasonably be expected to endanger or cause loss of life, inflict bodily harm or damage property. The applicant shall indemnify and hold harmless RECOM, its affiliated companies and its representatives against any damage claims in connection with the unauthorized use of RECOM products in such safety-critical applications.